

# TOSHIBA

*AIR TO WATER HEAT PUMP*

## Installation Manual

R32

**Hydro Unit -All In One Type-**

Model name:

---

**HWT-601F21SM3W-E**

**HWT-601F21ST6W-E**

**HWT-1101F21SM3W-E**

**HWT-1101F21MM3W-E**

**HWT-1101F21ST6W-E**

**HWT-1101F21MT6W-E**

**HWT-1101F21ST9W-E**

**HWT-1101F21MT9W-E**

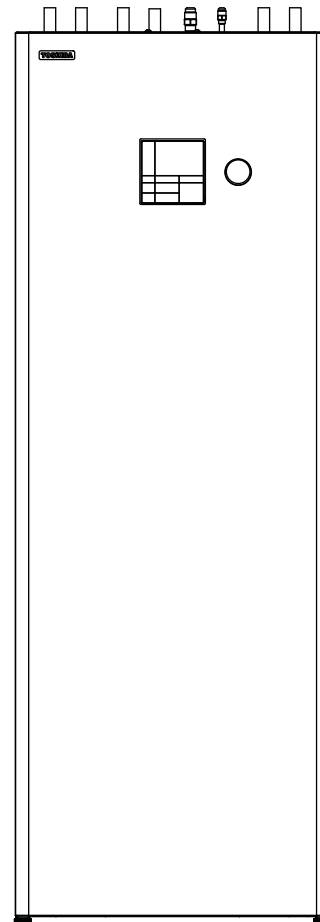

Original instructions

- Please read this Installation Manual carefully before installing the Air to Water Heat Pump.
- This Manual describes the installation method of the Hydro Unit.
  - For installation of the Outdoor Unit, follow the Installation Manual attached to the Outdoor Unit.
  - This system is for residential use only.

**REFRIGERANT**

This Air to Water Heat Pump uses an HFC refrigerant (R32) in order to prevent destruction of the ozone layer.

**Contents**

1 General information . . . . . 1

2 Accessory parts . . . . . 2

3 Preparations for installation . . . . . 3

4 Precautions for safety . . . . . 3

5 Example of Hydro Unit installation. . . . . 6

6 Main components of Hydro Unit . . . . . 7

7 Hydro Unit installation. . . . . 8

8 Group control and optional controllers . . . . . 19

9 Start up and configuration . . . . . 20

10 Maintenance . . . . . 32

11 Troubleshooting . . . . . 33

12 Technical parameters . . . . . 37

# 1 General information

## ■ System combination

Hydro Unit	Outdoor Unit						Backup heater	Zone2 Control
	HWT-401HW-E	HWT-601HW-E	HWT-801HW-E	HWT-1101HW-E	HWT-801HRW-E	HWT-1101HRW-E		
HWT-601F21SM3W-E	○	○	—	—	—	—	~, 3kW	—
HWT-601F21ST6W-E	○	○	—	—	—	—	3N ~, 6kW	—
HWT-1101F21SM3W-E	—	—	○	○	○	○	~, 3kW	—
HWT-1101F21MM3W-E	—	—	○	○	○	○	~, 3kW	○
HWT-1101F21ST6W-E	—	—	○	○	○	○	3N ~, 6kW	—
HWT-1101F21MT6W-E	—	—	○	○	○	○	3N ~, 6kW	○
HWT-1101F21ST9W-E	—	—	○	○	○	○	3N ~, 9kW	—
HWT-1101F21MT9W-E	—	—	○	○	○	○	3N ~, 9kW	○
	Single phase model				Single phase with Cord Heater			

## ■ General specifications

### Outdoor Unit

#### Single Phase model

Outdoor Unit		HWT-401HW-E	HWT-601HW-E	HWT-801HW-E	HWT-1101HW-E
Power supply		220-240 V ~ 50 Hz			
Type		INVERTER			
Function		Heating & Cooling			
Heating	Capacity (kW)	4.0	6.0	8.0	11.0
	Input (kW)	0.77	1.25	1.54	2.39
	COP (W/W)	5.20	4.80	5.19	4.60
Cooling	Capacity (kW)	4.0	5.0	6.0	8.0
	Input (kW)	1.16	1.52	1.88	2.86
	EER (W/W)	3.45	3.30	3.20	2.80
Refrigerant		R32			
Dimension	H x W x D (mm)	630 x 800 x 300		1,050 x 1,010 x 370	

Outdoor Unit		with Cord heater	
		HWT-801HRW-E	HWT-1101HRW-E
Power supply		220-240 V ~ 50 Hz	
Type		INVERTER	
Function		Heating & Cooling	
Heating	Capacity (kW)	8.0	11.0
	Input (kW)	1.54	2.39
	COP	5.19	4.60
Cooling	Capacity (kW)	6.0	8.0
	Input (kW)	1.88	2.86
	EER	3.20	2.80
Refrigerant		R32	
Dimension	HxWxD (mm)	1,050 x 1,010 x 370	
Cord heater	(W)	150	

**Hydro Unit****4 kW, 6 kW model**

Hydro Unit		HWT-601F21SM3W-E	HWT-601F21ST6W-E
Back up heater capacity	(kW)	3.0	6.0
Power supply	for back up heater	220-240 V ~ 50 Hz	380-415 V 3N ~ 50 Hz
Leaving water temperature	Heating	(°C) 20-55	
	Cooling	(°C) 7-25	
Max water temperature for DHW	(°C)	65	
Dimension	H x W x D (mm)	1,700 x 600 x 670	
Volume DHW tank	(L)	210	
Pressure setting, DHW safety valve	(MPaG)	0.6	
Pressure setting, Space heating safety valve	(MPaG)	0.25	

**8 kW, 11 kW model**

Hydro Unit		HWT-1101F21SM3W-E HWT-1101F21MM3W-E	HWT-1101F21ST6W-E HWT-1101F21MT6W-E	HWT-1101F21ST9W-E HWT-1101F21MT9W-E
Back up heater capacity	(kW)	3.0	6.0	6.0
Power supply	for back up heater	220-240 V ~ 50 Hz	380-415 V 3N ~ 50 Hz	380-415 V 3N ~ 50 Hz
Leaving water temperature	Heating	(°C) 20-65		
	Cooling	(°C) 7-25		
Max water temperature for DHW	(°C)	65		
Dimension	H x W x D (mm)	1,700 x 600 x 670		
Volume DHW tank	(L)	210		
Pressure setting, DHW safety valve	(MPaG)	0.6		
Pressure setting, Space heating safety valve	(MPaG)	0.25		

## 2 Accessory parts

No.	Parts name	Quantity
1	Installation Manual (this document)	1
2	Owner's Manual	1
3	CD	1

## 3 Preparations for installation

### ■ Parts required to connect this product (Common items)

Category	Part	Specification	Quantity
Water piping	Drain cock	(for water charge)	1
	Isolating ball valves	1" for service 1"	2
Electrical system	Earth leakage breaker for main power supply	30 mA	1
	Earth leakage breaker for backup heater	30 mA	1

### ■ Options required for each function

Purpose	In the Hydro Unit		Purchased part	
	Part name	Model name	Part name	Prescribed specification
Heating	-	-	Radiator(s), Fan coil(s), Under floor heating	
Heating & Cooling (all rooms)	-	-	Fan coil(s)	
Heating & Cooling (partly heating only)	-	-	Motorized 2-way valve (for cooling)	Refer to "Control parts specifications" on page 13.
Interlocking with boiler	-	-	Boiler	Other power supply. Signal 12 V input function is required for boiler.

## 4 Precautions for safety

### ■ General safety precautions

Ensure that all Local, National and International regulations are satisfied.

- Read the "Precautions for safety" carefully before installation.
- The precautions described below include the important items regarding safety – Observe them without fail.
- After the installation work has been completed, perform a test run to check for any problems. Follow the Owner's Manual to explain how to use and maintain the unit to the customer.
- Turn off the main power supply switch (or breaker) before unit maintenance.
- Ask the customer to keep the Installation Manual along with the Owner's Manual.

### ■ Refrigerant precautions

- If a refrigerant leak is suspected contact the dealer who supplied the system, in the case of a recharge of refrigerant ask service personnel for details of the leak and confirmation of the repairs completed.
- Generally the refrigerant does not leak, however, if the refrigerant should leak into a room and a heater or stove burner in the room is lit, toxic gas may be generated.
- Do not install the system in a location subject to a risk of exposure to a combustible gas.  
If a combustible gas leaks and stays around the unit a fire may occur.

- Install the refrigerant pipe securely during installation and before operation.

If the compressor is operated with no pipe work connected and valves open the compressor will suck air which would result in over pressurization of the system which may result in bursting or injury.

Observe the same precautions for refrigerant recovery work (pump back procedure to Outdoor Unit) and do not disconnect pipe work until refrigerant is recovered and valves closed.

## WARNING

### Installation precautions

- Ask an authorized dealer or qualified installation professional to install/maintain the Air to Water Heat Pump System. Inappropriate installation may result in water leaks, electric shock or fire.
- Electrical work must be performed by a qualified electrician in accordance with the installation manual. An inappropriate power supply capacity or installation may result in fire.
- When completing any electrical works to the system ensure that all Local, National and International regulations are satisfied. Inappropriate grounding may result in electric shock.
- Ensure all electrical cables, used for the Hydro Unit installation, comply with all Local and National regulations. Check all electrical terminations are secure and tight.
- Earth wire connections.
- Install an earth leakage breaker without fail. Incomplete grounding can cause electric shock. Do not earth wires to gas pipes, water pipes, lightning rods or telephone cable earth wires.
- This unit must be connected to the main power supply using a circuit breaker or switch with a contact separation of at least 3 mm.
- Be sure to turn off all main power supply switches or the circuit breaker before starting any electrical work. Ensure all power switches are off, failure to do so can cause electric shock. Use an exclusive power circuit for the Air to Water Heat Pump system using the rated voltage.
- Ensure correct connection of interconnecting wire between Outdoor Unit and Hydro Unit. Incorrect connection of the interconnecting cable may result in the damage of electrical parts.

- Under no circumstances must the power cable be extended. Poor connections, where the cables are joined, may give rise to smoking and/or fire.
- Ensure refrigeration system remains sealed to external gases and air. Should air or other gases contaminate the refrigeration circuit, high system pressures could result in burst pipes and injuries.
- Do not modify or bypass any of safety guards or switches in this system.
- After unpacking the Outdoor Unit, examine the unit carefully for any possible damage.
- Do not install in any place that might increase the vibration of the unit.
- To avoid personal injury (with sharp edges), be careful when handling the Hydro Unit.
- Due to the heavy weight of the unit, please ensure appropriate levels of care, is taken when moving and positioning the unit into its final location.
- Perform installation work properly in accordance with the installation manual. Inappropriate installation may result in water leaks, electric shock or fire.
- Tighten all flare nuts with a torque wrench in the specified manner. Excessive tightening of the flare nut may result in cracking of the pipe work or flare nut which may result in a refrigerant leakage.
- Wear heavy duty gloves during installation work to avoid injury.
- Install the Outdoor Unit securely in a location where the base can sustain the weight adequately.
- In enclosed areas, if the refrigerant leaks during installation vacate and ventilate immediately.

- After installation is complete ensure and confirm that refrigerant does not leak. If refrigerant leaks into a room and flows near a fire source noxious gas may be generated.
  - Do not block any drain hoses. Hoses may come off and electric shocks may occur.
  - Install in room with water drain.
  - This appliance is intended to be permanently connected to the water mains and not connected by a hose set.
  - The maximum inlet water pressure for DHW is 0.6 MPa.
  - The maximum inlet water pressure for space heating is 0.25 MPa.
  - The minimum inlet water pressure for space heating is 0.05 MPa.
-

## ■ Notes on system design

- The inlet water temperature for space heating to the Hydro Unit for HWT-110 must be 65 °C or less. (For HWT-60 must be 55 °C or less.)  
Especially, be careful when there is an external heating source such as a boiler.  
When hot water over 65 °C or 55 °C returns, it may result in a failure of the unit or water leakage.
- The flow rate of the circulating water must meet the following range.  
11 kW 13 L/minute or more  
6 kW 10 L/minute or more  
If the flow rate becomes less than the minimum, the protective device is activated to stop the operation.  
To ensure the minimum flow rate of the water system, install a bypass valve on one water circuit. Please note this circuit must contain a minimum of 20 liters. If total water amount is not enough, the unit may not function fully due to protective operation.
- Do not drive water by power other than the pump built in the Hydro Unit.
- The back up heaters, in the Hydro Unit, are designed to assist the heat pump during periods of low ambient conditions and during domestic hot water (DHW) production.
- Ensure the Hydro Unit and the connecting water pipes are installed in a location that is not exposed to low ambient temperatures which could result in the water circuit freezing.
- The system operation is designed around a closed water circuit. Do not use an open circuit design.
- Please turn on the main power supply to up to 12 hours before the system is started and ensure the power remains switched on for the period of use.

## 5 Example of Hydro Unit installation

### ■ Example of installation for cooling and heating

When both cooling and heating modes are required a 2-way valve must be installed to isolate the radiator or under-floor heating circuit.

▼ Fig.5-01

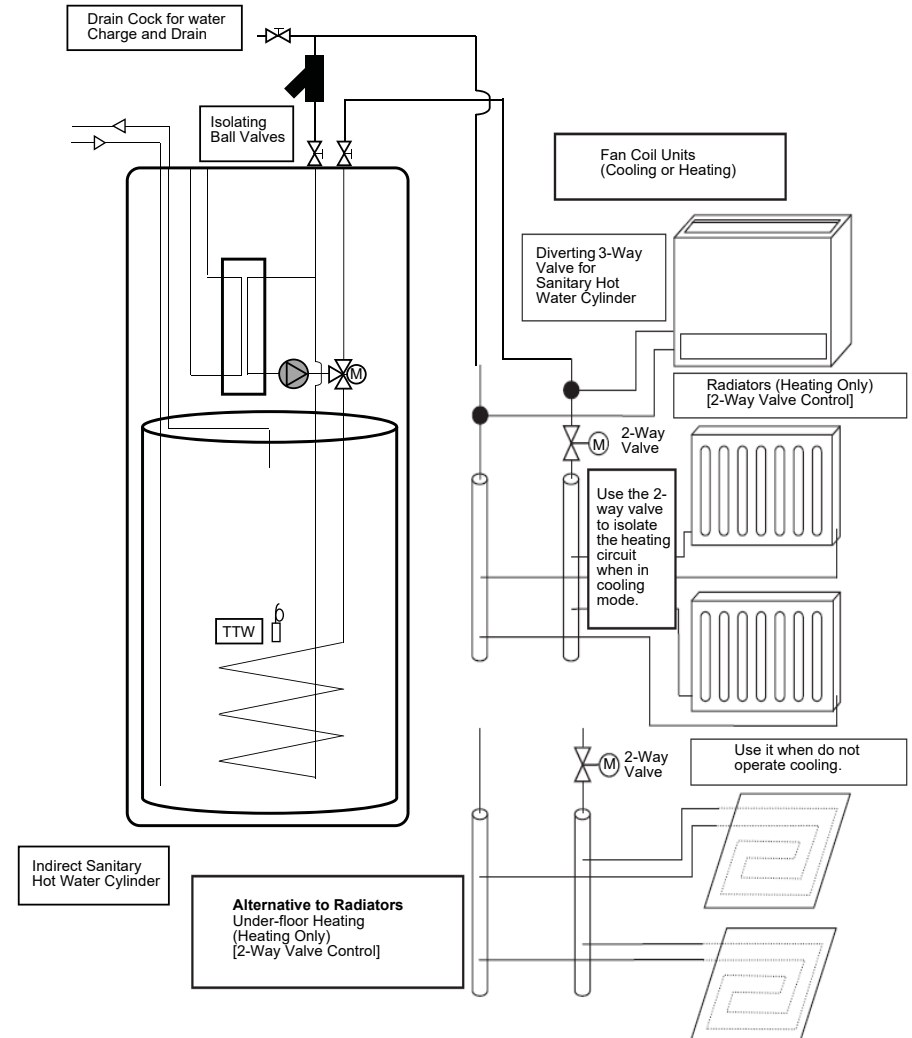

## ■ Example of 2-zone temperature control and hot water supply system

The following shows an example of the 2-zone temperature control.

▼ Fig.5-02

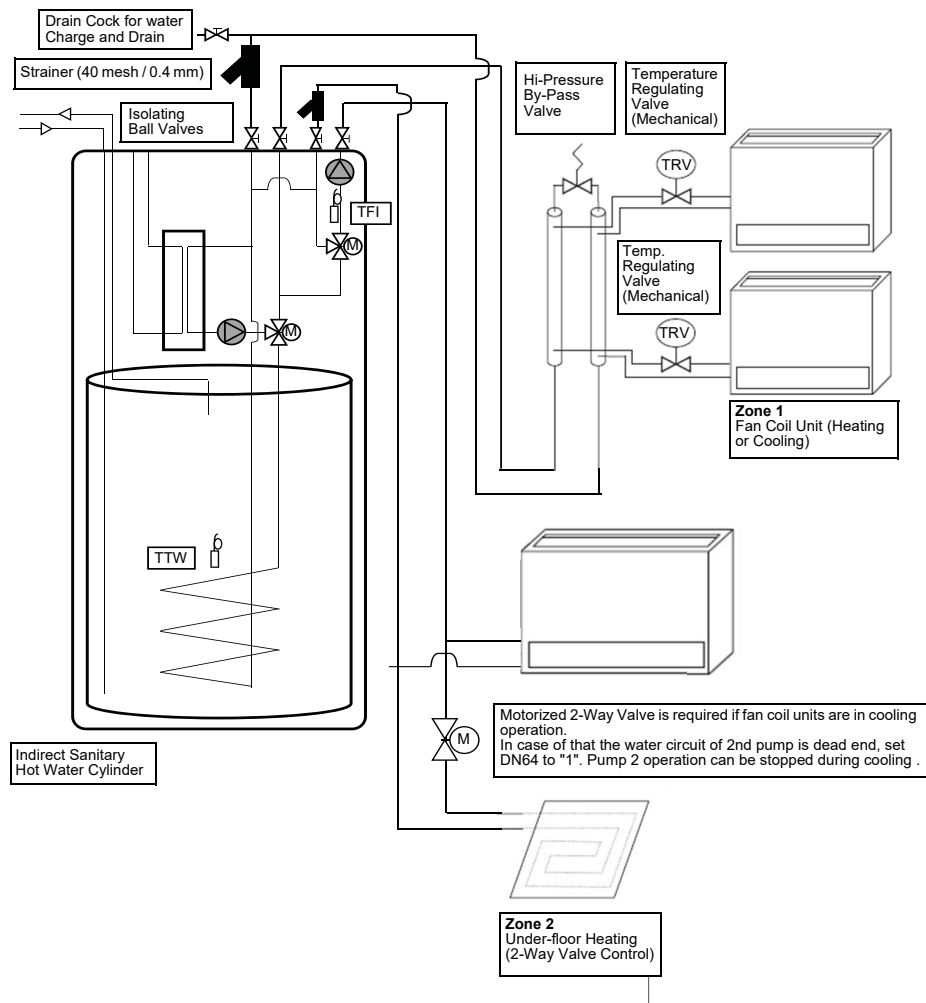

## 6 Main components of Hydro Unit

### ■ Exploded view and description for Hydro Unit

▼ Fig.6-01

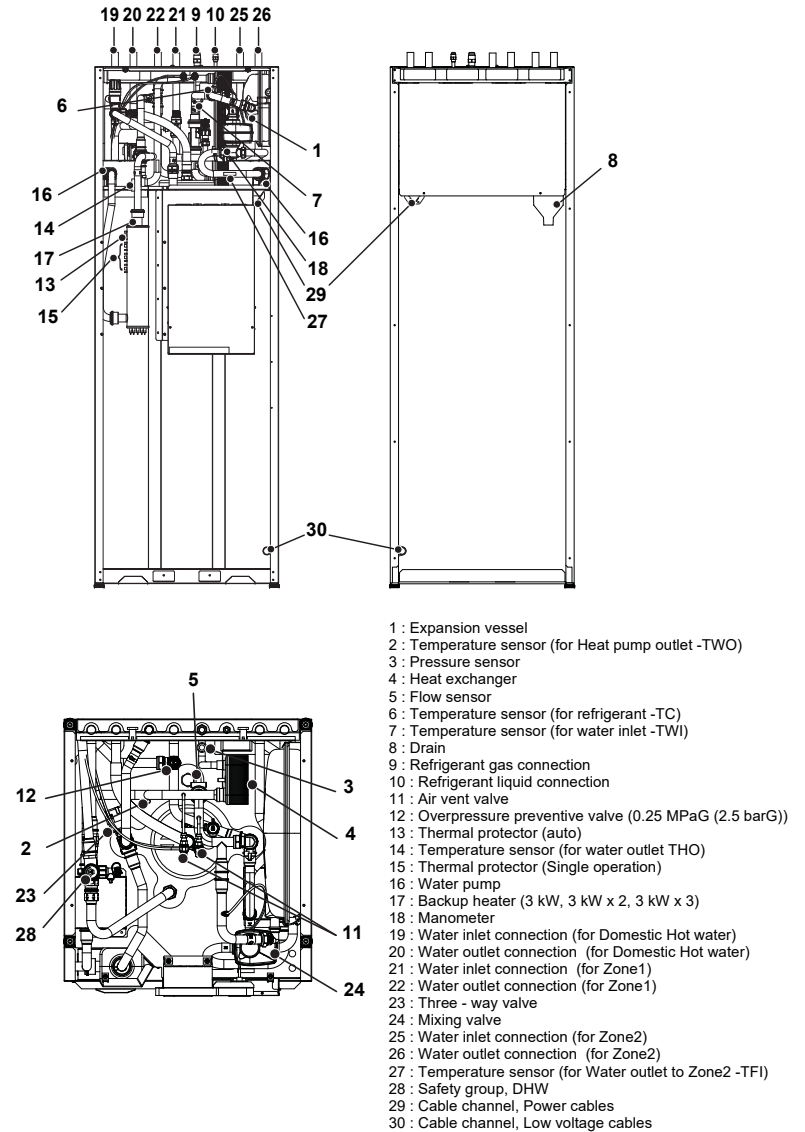



## ■ E-box layout

▼ Fig.6-02

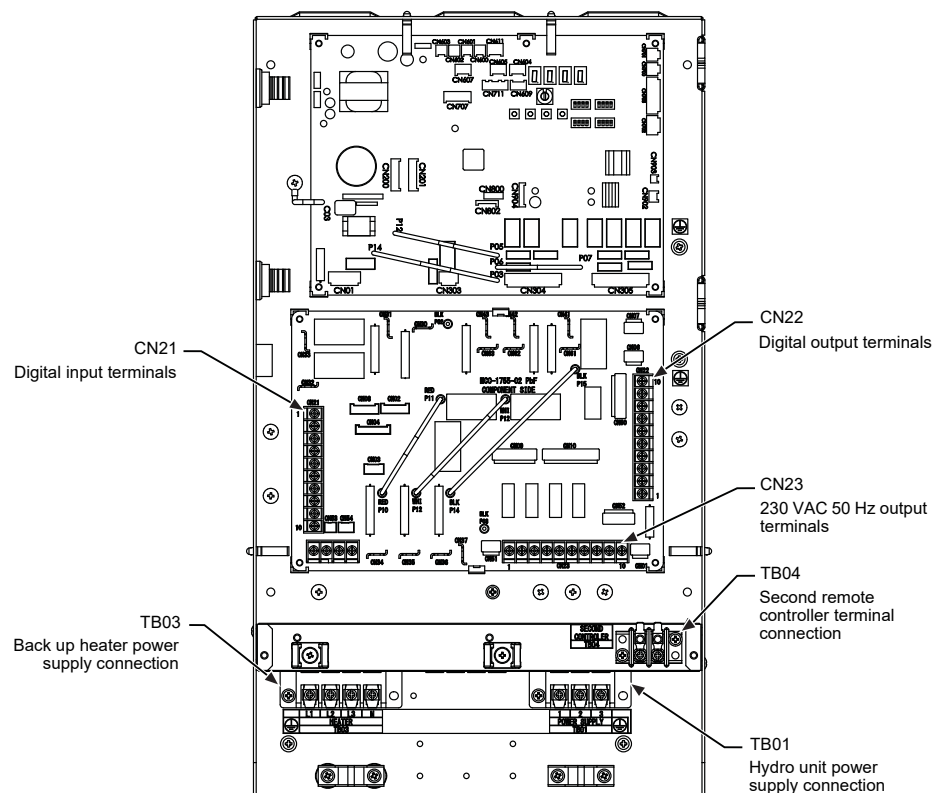

# 7 Hydro Unit installation

## ⚠ WARNING

- To protect yourself from injury, always use PPE (Personal Protective Equipment), that is, wear gloves.
- Install the Hydro Unit by at least four persons.
- Install the Hydro Unit in a place strong enough to withstand the following weights:  
The dry weight of the Hydro Units displayed on the product nameplate. When the Hydro Unit, is filled with water the weight of the unit will increase by 210 kg.

## ⚠ CAUTION

- Do not install the unit in a place where water freezes.
- Do not install the Hydro Unit in a place where combustible gas may leak.
- Do not install the Hydro Unit in a place exposed to rain or water.
- Do not install the Hydro Unit near equipment which generates heat.
- Do not install the Hydro Unit to a movable object.
- Do not install the Hydro Unit in a place exposed to vibration.
- The unit must be installed in accordance with national wiring regulation.
- The Hydro Unit must not be installed in a high humidity condition area.
- Must be installed accordance with national plumbing regulation.

## ■ Handling, unpacking, and checking the Hydro Unit

- The unit should be checked when it is delivered, and any damage reported immediately to the courier claims department.

## ■ Positioning

### Service space

Secure a service space for the Hydro Unit.

- Do not install the Hydro Unit in a place where heat stagnates.

▼ Fig.7-01

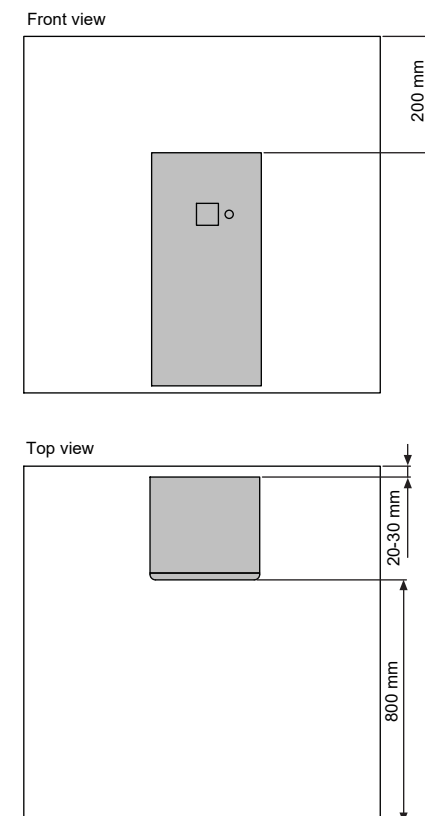

Install the Hydro Unit so that its tilting angle falls within the range below by use of the four adjustable feet.

▼ Fig.7-02

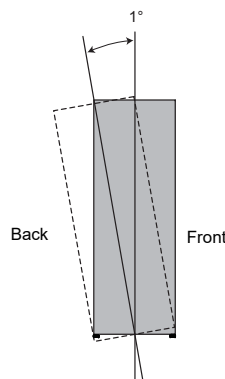

▼ Fig.7-03

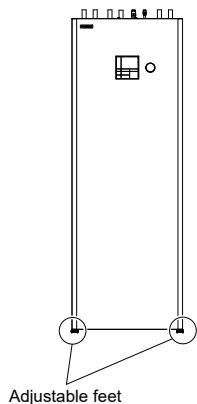
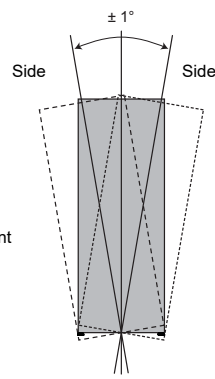

## Refrigerant piping

### WARNING

- THIS SYSTEM ADOPTS HFC REFRIGERANT (R32) WHICH DOES NOT DESTROY THE OZONE LAYER.
- Therefore during installation work prevention of the invasion of water, dust, former refrigerant or oil is of a paramount importance. To prevent the charging of incorrect refrigerants into the system the service valve connection ports have also increased in size.
- The use of R32 or R410A tools is required for correct installation of the system.
- The use of the correct pipe sizes and wall thicknesses of copper pipe work is required for the correct installation of the system.

### CAUTION

- Ensure all refrigerant pipes are protected from the invasion of dust and water.
- Ensure all pipe work connections are tightened to the required torque settings detailed in this section.
- Perform an air tight test using Oxygen Free Nitrogen (OFN) only.
- Evacuate the air in the pipe work using a vacuum pump.
- Check for refrigerant gas leaks at all connections throughout the pipe work.

### NOTE

The Air to Water Heat Pump System uses R32 refrigerant. It is important that copper pipes used for refrigerant piping have the following wall thickness:

- 0.8 mm for Ø6.4 mm, Ø9.5 mm and Ø12.7 mm
- 1.0 mm for Ø15.9 mm

## Refrigeration pipe

The length and height of the refrigeration pipe must be within the following values.

▼ Fig.7-04

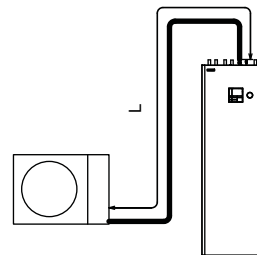

Hydro Unit Model	H:Max	L:Max	L:Min
HWT-60	±30 m (above or below)	30 m	5 m
HWT-110	±30 m (above or below)	30 m	5 m

## Refrigerant pipe sizes

Hydro Unit Model	Gas Side (mm)	Liquid Side (mm)
HWT-60	Ø 12.7	Ø 6.35
HWT-110	Ø 15.88	Ø 6.35

## Flaring

- Cut the refrigerant pipes to the correct length using a pipe cutter. Remove any burrs that may be on the pipes as these may cause refrigerant leaks or component failure in the refrigeration cycle.
- Place the correct size flare nuts onto the pipes (use the flare nuts supplied with the Hydro Unit or use flare nuts designed specifically for R32 refrigerant) and then flare the pipes using the correct flaring tool.

## Tightening

- Connect the refrigerant pipes, from the Outdoor Unit, to the Hydro Unit as shown below.

▼ Fig.7-05

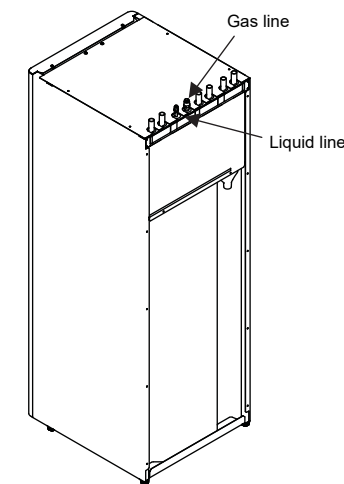

- Align the flare connection on each pipe with the corresponding outlet connection on the Hydro Unit. Tighten the flare nuts, using fingers, to secure the pipes in place.
- Tighten the flare nuts, using a torque wrench, to the tightening torques shown below:

Outer Ø of Copper Pipe (mm)	Tightening Torque (N/m)
Ø 6.35	14 to 18
Ø 12.7	50 to 62
Ø 15.88	63 to 77

- To prevent damage, to the refrigerant pipes, use two spanners to tighten the flare nut connections to the required torque.

## Water pipe

### WARNING

- Install water pipes according to the regulations of respective countries.
- Install water pipes in a freeze-free place.
- Make sure that water pipes have sufficient pressure resistance.  
The setting value of the overpressure preventive valve is 0.25 MPaG (2.5 barG).

### CAUTION

- Do not use zinc plated water pipes. When steel pipes are used, insulate both ends of the pipes.
- The water to be used must meet the water quality standard specified in EN directive 98/83 EC.

### Water pipe

- Design the water pipe length within the QH characteristics of the pump (Refer to "Fig.7-10" and "Fig.7-11" on page 11).  
The height of the pipe must be 7 m or less.
- Connections Ø22 compression fitting.

▼ Fig.7-06

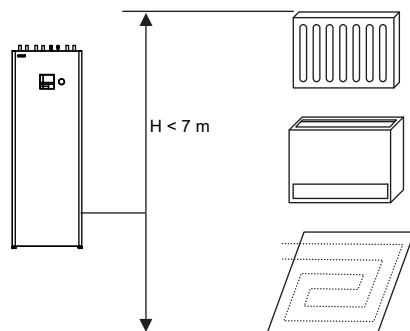

▼ Fig.7-07

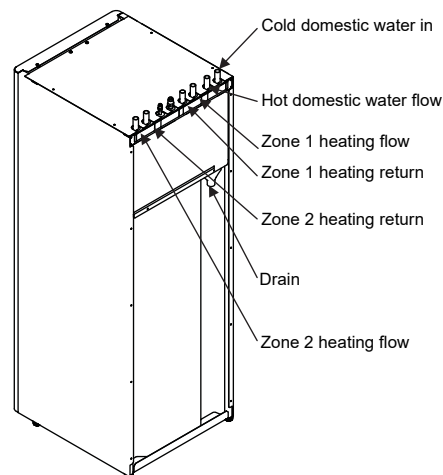

▼ Fig.7-08

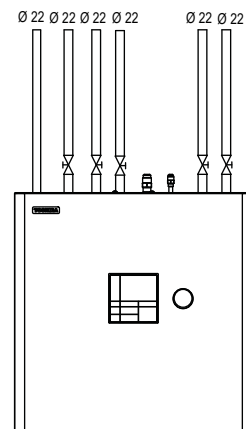

### Water circuit - Space heating

- Install drain cocks (locally produced) for water charge and discharge. Alternatively, use the water charge valve inside the unit.
- Make the piping route a closed circuit (An open circuit may cause failure).
- The AIO has two built-in manual air relief valves for start-up purposes. It is recommended to install automatic deaerators on appropriate locations in the associated pipe works.

### Water circuit - Domestic water

- Connect the cold water inlet to the cold water supply. The AIO has a built in safety group.
- The safety group has a pressure relief valve/safety valve right before the domestic hot water tank inlet to protect the water tank and associated pipe work against excessive pressures when the domestic water expands during the heating process.  
The back pressure valve (check valve), which is installed in front of the pressure relief valve, prevents water from the tank flowing back into the cold water pipe. Therefore, the pressure in the water tank rises to the maximum setting of the pressure relief valve and the pressure relief valve opens. The redundant water discharges.  
If the pressure relief valve did not open, the water tank would burst.  
The pressure relief valve must be operated regularly to remove lime scale/deposits and to verify that it is not blocked. It is tested by turning the handle on the pressure relief valve while checking that water discharges.  
Damages due to a faulty pressure relief valve are not covered by the warranty.  
Please note that water may drip from the discharge pipe of the pressure-relief valve due to heating of the water. This water collects into the AIO common drain funnel.

### Unit drainage

- The AIO has a combined drain funnel (Refer to "Fig.6-01(8)"), collecting drain from the domestic water safety group, the space heating safety group, and the space heating air relief valves.
- Install a drain pipe from the drain funnels to a building drain.
- Always ensure free drainage and no locks on the drain pipe.

**Checking water volume and initial pressure of expansion vessel for Heating**

The expansion vessel of the Hydro Unit has a capacity of 10 liters.  
 The initial pressure of the expansion vessel is 0.05 MPa (0.5 bar).  
 The pressure of the safety valve is 0.25 MPa (2.5 bar).  
 Verify whether the capacity of the expansion vessel is sufficient using the following expression. If the volume is insufficient, add the capacity locally.

**Expression for expansion vessel selection**

$$V = \frac{\epsilon \times V_s}{1 - \frac{P_1}{P_2}}$$

- V: Necessary total tank capacity (ℓ)
- ε: Water expansion coefficient at each hot water temperature
- Vs: Total water amount in the system
- P1: System pressure at tank setting position (MPaabs.)  
 = water supply pressure = 0.15 (MPaabs.) (recommended value)
- P2: Maximum pressure used during operation at tank setting position (MPaabs.)  
 = safety valve setting pressure = 0.35 (MPaabs.)
- \* The absolute pressure value (abs.) is obtained by adding the atmospheric pressure (0.1 MPa (1 bar)) to the gauge pressure.

**▼ Tank selection method**

Water temperature and expansion coefficient			
Hot water temperature (°C)	Expansion rate ε	Hot water temperature (°C)	Expansion rate ε
0	0.0002	50	0.0121
4	0.0000	55	0.0145
5	0.0000	60	0.0171
10	0.0003	65	0.0198
15	0.0008	70	0.0229
20	0.0017	75	0.0258
25	0.0029	80	0.0292
30	0.0043	85	0.0324
35	0.0050	90	0.0361
40	0.0078		
45	0.0100		

▼ Fig.7-09

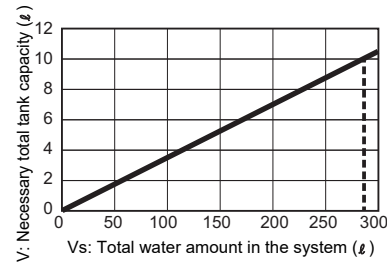

\*In case the maximum hot water temperature is 65°C  
 Install an external expansion vessel when the capacity of the expansion vessel is insufficient.

**Pump operation/configuration**

▼ Fig.7-10

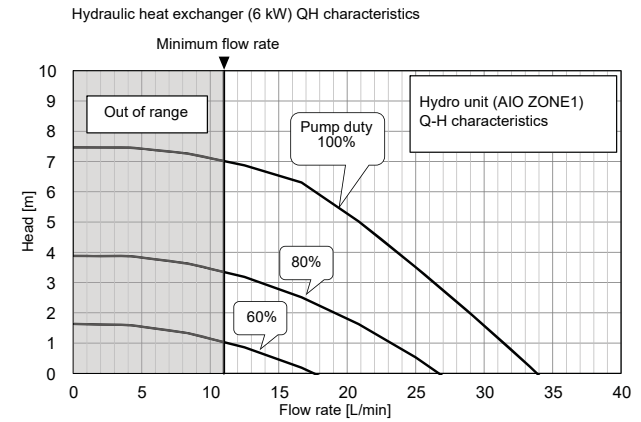

▼ Fig.7-11

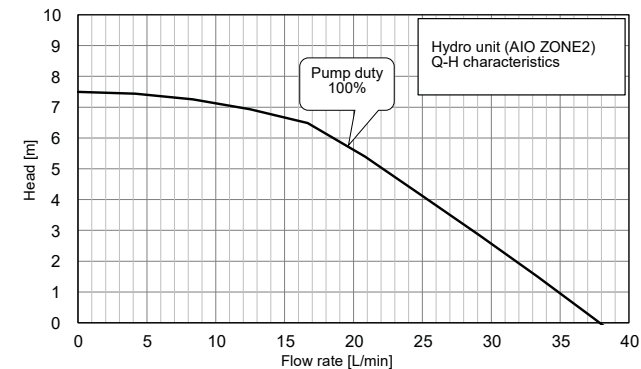
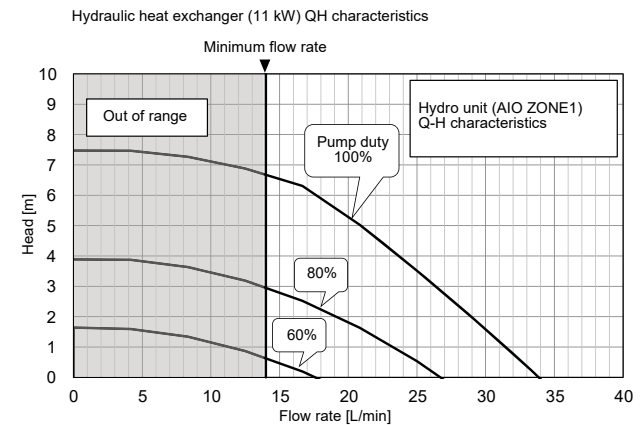

**Water charging - Space heating**

Fill the system with water until the pressure gauge shows the recommended pressure value of 0.15 MPa (1.5 bar).

Release air from the system by opening the two air relief valves (Torx 20).

Hydraulic pressure may drop when the trial run begins. In that case, add water.

Air may enter if the charged hydraulic pressure is low. Operate the air relief valves until no further air escapes the system.

**Water charging - Domestic water**

- Open the cold water inlet to fill up the water cylinder. Ensure also that the ball valve in the safety group (Refer to "Fig.6-01(28)") is open.
- Ensure that a hot water tapping point is open to deaerate the water cylinder and the associated pipe works.

▼ Fig.7-12

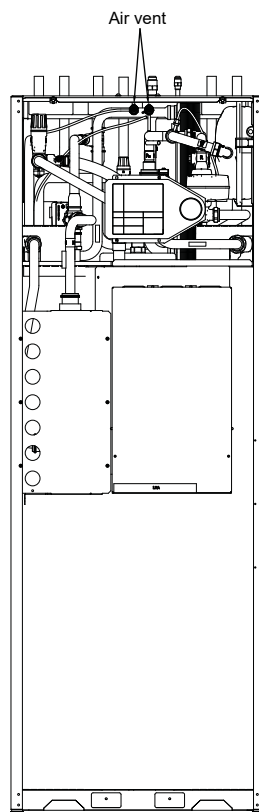

Loosen the air vent valve to release air. Water may come out of the air vent valve. Release the air completely from the water circuit. Failure to do so may disable correct operation.

**Water quality**

The water used must satisfy EN directive 98/83 EC.

**Piping insulation**

It is recommended that insulation treatment be applied to all pipes. To perform optional cooling operation, apply insulation treatment of 20 t or more to all pipes.

**■ Electrical installation****⚠ WARNING**

- Ensure electrical circuits are isolated before commencing the electrical installation.
- The electrical installation must be completed by a qualified electrician.
- The electrical installation must comply to all Local, National and International electrical installation regulations.
- This product must be earthed in accordance with Local, National and International electrical installation regulations.

**⚠ CAUTION**

- The Hydro Unit must be connected to a dedicated power supply for the back up heater circuit.
- The electrical supply must be protected by a suitably sized over current protection device (fuse, MCB etc) and an earth leakage protection device.
- The Hydro Unit must be connected to the mains power supply using an isolating switch which disconnects all poles and has a contact separation of at least 3 mm.
- The cord clamps, attached to the Hydro Unit, must be used to secure the electrical cables.
- Wrong connection of electrical cables may result in electrical component failure or fire.
- Ensure the electrical cables are sized in accordance with the installation instructions.
- Check that cabling will not be subject to wear, corrosion, excessive pressure, vibration, sharp edges or any other adverse environmental effects. The check shall also take into account the effects of aging or continual vibration from sources such as compressor or fans.

**Control line**

▼ Fig.7-13

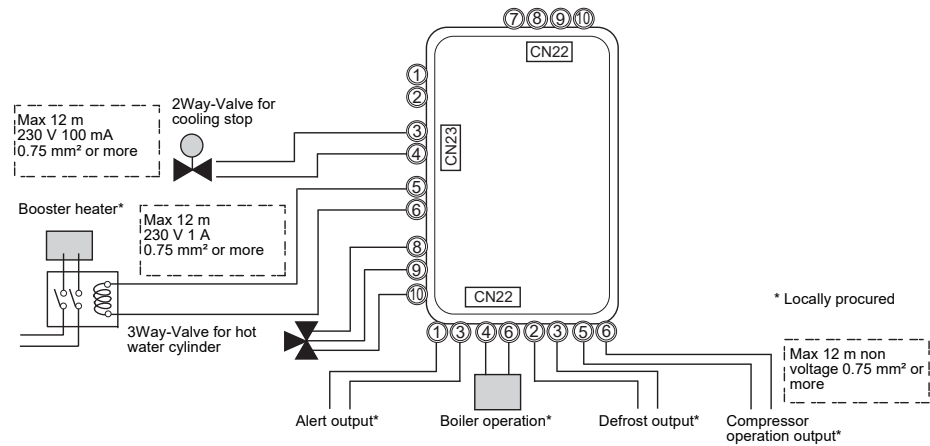

▼ Fig.7-14

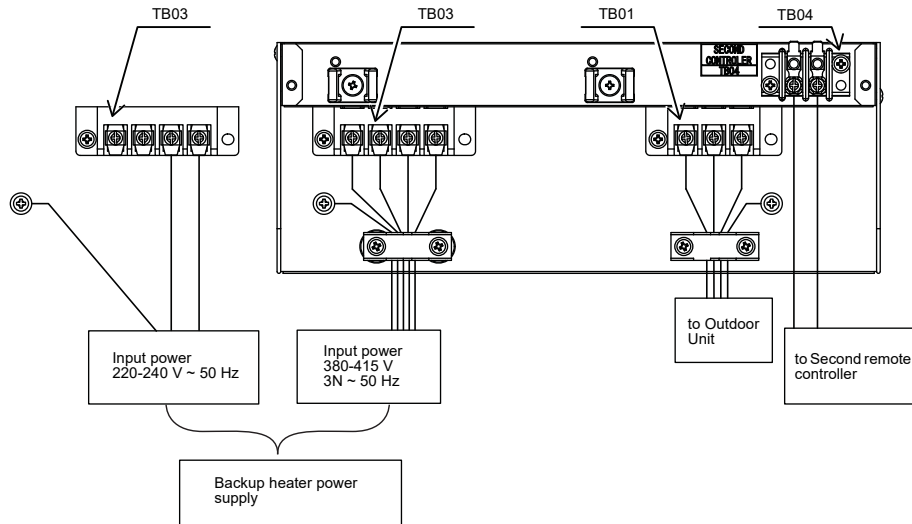

**Electrical supply/cable specifications**

▼ Wiring specifications

Description	Model name HWT-	POWER SUPPLY	Maximum current	Installation fuse rating	Power wire	Connection destination
Outdoor Unit power	1101H(R)W-E	220-240 V ~ 50 Hz	20.3 A	25 A	2.5 mm <sup>2</sup> or more	L, N
	801H(R)W-E	220-240 V ~ 50 Hz	20.3 A	25 A	2.5 mm <sup>2</sup> or more	
	601HW-E	220-240 V ~ 50 Hz	14.6 A	16 A	1.5 mm <sup>2</sup> or more	
	401HW-E	220-240 V ~ 50 Hz	14.6 A	16 A	1.5 mm <sup>2</sup> or more	
Hydro inlet heater power	1101F21SM3W-E 1101F21MM3W-E	220-240 V ~ 50 Hz	13 A	16 A	1.5 mm <sup>2</sup> or more	L, N
	1101F21ST6W-E 1101F21MT6W-E	380-415 V 3N ~ 50 Hz	13 A (13 A x 2P)	16 A	1.5 mm <sup>2</sup> or more	L1, L2, L3, N
	1101F21ST9W-E 1101F21MT9W-E	380-415 V 3N ~ 50 Hz	13 A (13 A x 3P)	16 A	1.5 mm <sup>2</sup> or more	L, N
	601F21SM3W-E	220-240 V ~ 50 Hz	13 A	16 A	1.5 mm <sup>2</sup> or more	L, N
	601F21ST6W-E	380-415 V 3N ~ 50 Hz	13 A (13 A x 2P)	16 A	1.5 mm <sup>2</sup> or more	L1, L2, L3, N

▼ Wiring specifications (control line)

Description	Line spec	Maximum current	Maximum length	Power wire	Connection destination
Second remote controller	2 line	50 mA	50 m	0.5 mm <sup>2</sup> or more	(TB04)
Group control (total)	2 line	50 mA	50 m	0.5 mm <sup>2</sup> or more	(TB04)
Open protocol interface	2 line	100 mA	50 m	0.5 mm <sup>2</sup> or more	(TB04)

▼ Control parts specifications

	Power	Maximum current	Type
Motorized 2-way valve (for cooling)	AC 230 V	100 mA	spring return type (normally open)

▼ Output line specifications

Description	Output	Maximum current	Max voltage	Maximum length	
External boost heater	AC230 V	1 A	-	12 m	Output as required when outdoor air temperature is -20 °C or less
Digital outputs from CN22	Non-voltage contacts	0.5 A	AC230 V	12 m	
		1 A	DC24 V	12 m	

▼ Input line specifications

Description	Input	Maximum length
Digital inputs to CN21	Non-voltage	12 m

**CAUTION**

**Earthing arrangements**

The Hydro Unit and related equipment must be earthed in accordance with your local and national electrical regulations. It is essential that the equipment is earthed to prevent the electric shock and damage to the equipment.

**Electrical connection to Hydro Unit for backup heater**

- Remove the front cover and the electrical box cover from the Hydro Unit.
- The Hydro Unit power cable must be sized in accordance with refer to “Electrical supply/cable specifications”.
- Connect the Hydro Unit power cable to Terminal 03 as shown below.

▼ Fig.7-15

Backup heater  
220-240 V ~ type  
(3 kW type)

Backup heater  
380-415 V 3N~  
type  
(6,9 kW type)

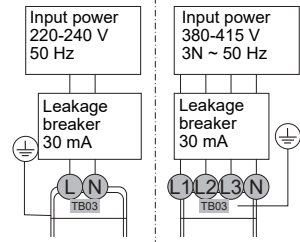

- Ensure the Hydro Unit power cable is secured using the cable clamp fitted in the electrical box.
- Ensure the Hydro Unit power cable connection terminals are tight.

**3kW type**

TB03			
1	2	3	4
		L	N

**6kW, 9kW type**

TB03			
1	2	3	4
L1	L2	L3	N

**Outdoor Unit to Hydro Unit electrical connection**

▼ Fig.7-16

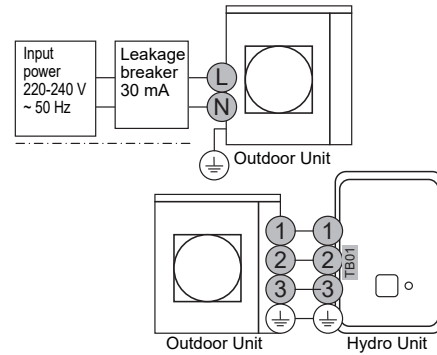

- Ensure electrical circuits are isolated before commencing work.
- The Outdoor Unit to Hydro Unit interconnecting cable must be sized in accordance with refer to “Electrical supply/cable specifications”.
- Connect the Outdoor Unit to Hydro Unit interconnecting cable as shown in the diagram above.
- Ensure the Outdoor Unit to Hydro Unit interconnecting cable is secured using the cable clamp fitted in the electrical box.
- Ensure the Outdoor Unit to Hydro Unit interconnecting cable connection terminals are tight.

**Electrical connection for external booster heater**

**CAUTION**

- **The maximum current available from the booster heater output is 1 A. Do not connect the booster heater directly to CN23 on the Hydro Unit. A separate contactor, supplied locally, must be used to supply the booster heater.**
- The booster heater can be installed only for room heating and cannot be used for hot water supply. The booster heater is an external heater, supplied locally, used to assist the Hydro Unit during low ambient conditions.
- The AC230 V 1 A output from the Hydro Unit must only be used to energize an external contactor. (Supplied locally)
- The output from the Hydro Unit is only enabled when the outdoor air temperature is less than -20°C.(\*)
- Ensure the external booster heater is installed and set up in accordance with all Local, National and International regulations.  
(\* ) For HWT-110, it is less than -25°C.

▼ Fig.7-17

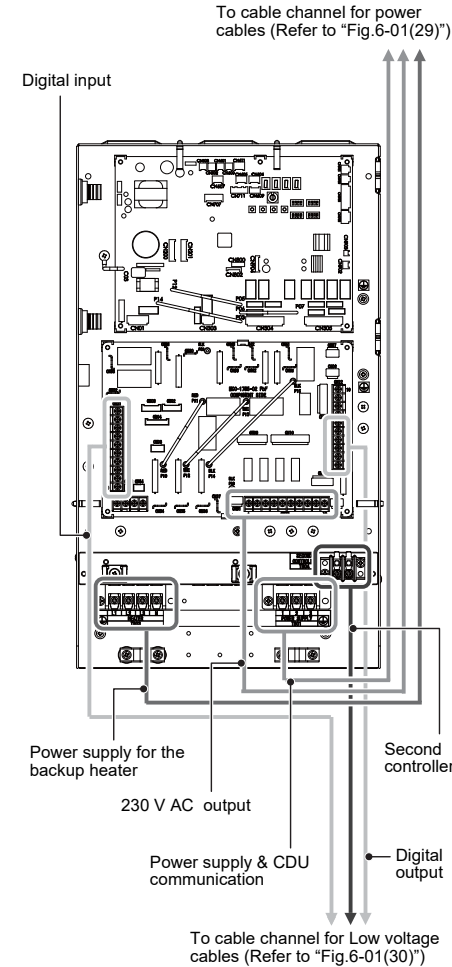
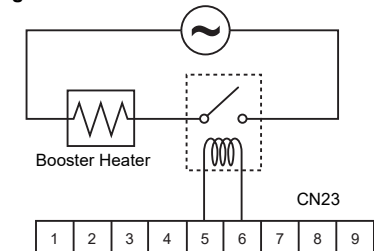

**Additional Hydro Unit outputs**

This unit has four output ports. They are selectable by DN. Table1 shows the selectable output functions and default settings.

**Volt free contact – specification show below:**  
**AC230 V; 0.5 A (maximum)**  
**DC24 V; 1 A (maximum)**  
**Minimum current; 10 mA**

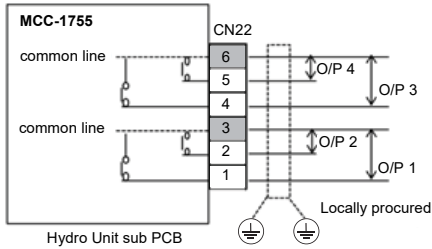

▼ Table1

Default setting	
O/P 1 (DN: 6CA)	Alarm output
O/P 2 (DN: 6CC)	Defrost operation output
O/P 3 (DN: 6CD)	Boiler control output
O/P 4 (DN: 6CB)	Compressor operation output
Selectable output items (DN: 6CA-6CD)	
0	Alarm output
1	Compressor operation output
2	Defrost operation output
3	Boiler control output
4	Safety or protection control running
5	During backup heater running
6	During hot water cylinder heater running
7	Heating operation output
8	Cooling operation output
9	Hot water operation output

0: Alarm output

Open: No alarm  
 Close: Alarm

1: Compressor operation output

Open: Compressor is stopping  
 Close: Compressor is operating

2: Defrost operation output

Open: Unit is not defrost operating  
 Close: Unit is defrost operating

3: Boiler control output

Open: Normal operation  
 Close: Boiler operation output

4: During safety or protection control running

Open: Normal operation  
 Close: Release control running

5: During backup heater running

Open: Backup heater not running  
 Close: Backup heater running

6: During hot water cylinder heater running

Open: Hot water cylinder heater not running  
 Close: Hot water cylinder heater running

7: Heating operation output

Open: Not heating operation  
 Close: Heating operation  
 (Include HP, Heater and thermo off.)

8: Cooling operation output

Open: Not cooling operation  
 Close: Cooling operation  
 (Include HP and thermo off.)

9: Hot water operation output

Open: Not hot water operation  
 Close: Hot water operation  
 (Include HP, Heater and thermo off.)

**Optional inputs to Hydro Unit**

This unit has eight input ports. 2 ports of them are selectable by DN. Table2 shows the selectable input functions and default settings.

**Non-voltage contacts**

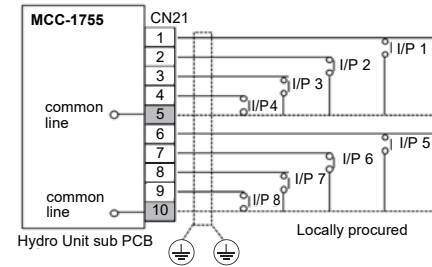

▼ Table2

Input items (Default setting)	
I/P 1	Room thermostat input for heating
I/P 2	Room thermostat input for cooling
I/P 3	Hot water tank thermostat input
I/P 4	Heating/cooling mode switching input
I/P 5	Heating/cooling operation ON/OFF
I/P 6	Hot water operation ON/OFF
I/P 7 (DN: B6)	0: Emergency shutdown input
I/P 8 (DN: B6)	0: None

**Selectable input items (DN: B6)**

DN: B6	CN21	Item
0	8-10	Emergency Shutdown input
	9-10	None
1	8-10	TEMPO control input 1
	9-10	None
2	8-10	TEMPO control input 2
	9-10	None
3	8-10	Forcibly turn off the backup heater
	9-10	Forcibly turn off the hot water tank heater
4	8-10	Smart Grid network input 1
	9-10	Smart Grid network input 2

I/P1 & I/P2: Room thermostat input

• Setting : DN [6B3] = 1  
 • Non-voltage contacts  
 Thermostat operation

CN21	Heating		Cooling	
	Reach	Not reach	Reach	Not reach
1-5 (I/P1)	open	close	-	-
2-5 (I/P2)	-	-	close	open

I/P3: Hot water tank thermostat input

• This function is used, when the customer use the local hot water tank.  
 • Setting : DN [6B2] = 1  
 • Non-voltage contacts  
 Open: Reached setting temperature  
 Close: Not reached setting temperature

I/P4: Heating/cooling mode switching input

• Non-voltage contact  
 Open: Heating mode  
 Close: Cooling mode

I/P5: Heating/cooling operation ON/OFF input

• Non-voltage contact  
 Open: Operation OFF (Remote controller OFF)  
 Close: Operation ON (Remote controller ON)

I/P6: Hot water operation ON/OFF input

• Non-voltage contact  
 Open: Operation OFF (Remote controller OFF)  
 Close: Operation ON (Remote controller ON)

I/P7 & I/P8: Connection to a Smart Grid network (SG Ready)

• Non-voltage contacts  
 • The operating mode is controlled through volt free contacts incorporated into the energy meter.  
 • Setting: DN [B6] = 4

0: Open, 1: Close

I/P7	I/P8	Operation Mode
0	0	Restricted Operation
1	0	System OFF
0	1	Normal Operation
1	1	System Forced ON



**Restricted Operation**

- Maximum compressor frequency is limited.
- System OFF
- System safety controls (e.g. freeze protection) will remain active.

**Normal Operation**

- This is not a START signal, only a recommendation to start.

**System Forced ON**

- The space heating set point temperature is increased during this period. The temperature increase can be adjusted using a new DN "DN [AC]". (0 ~ 10 K)
- ON/OFF delay of the Hydro Unit back up heater changes from 10 min to 0.

DN [6CE] = 0: HP and back up heaters ON

DN [6CE] = 1: HP only operation

- The Hot water control changes to Hot water boost control.

**I/P7: TEMPO1 signal input**

- DN [B6] = 1
  - Non-voltage contacts
  - When the TEMPO signal is input (the circuit is closed), the boiler signal is output regardless the outside temperature and devices are turned off Heater.
- Basic operation: heating operation using the boiler.
  - Switching to hot water supply: the water circuit is switched to the hot water supply side as the unit detect that TTW is less than 38°C.
  - Switching to heating: the water circuit is switched to the heating side as the unit detect that TTW is 45°C or more, or 30 minutes has passed since operation started. Heating operation continues at least 30 minutes.
  - The LED on the PC board lights up when the input signal is ON.

**I/P7: TEMPO2 signal input**

- DN [B6] = 2
  - Non-voltage contacts
  - When the TEMPO signal is input (the circuit is closed), the boiler signal is output regardless the outside temperature and devices are turned off heater, inlet pump, heat pump.
- Basic operation: heating operation using the boiler.
  - Switching to hot water supply: the water circuit is switched to the hot water supply side as the unit detect that TTW is less than 38°C.
  - Switching to heating: the water circuit is switched to the heating side as the unit detect that TTW is 45°C or more, or 30 minutes has passed since operation started. Heating operation continues at least 30 minutes.

- The LED on the PC board lights up when the input signal is ON.

**I/P7 & I/P8: Forcibly turn off heaters**

- Non-voltage contacts
- DN [B6] = 3
- I/P7: Forcibly turn off the backup heater
- I/P8: Forcibly turn off the hot water tank heater
- Open: Normal operation
- Close: Forcibly turn off the heater

**I/P7: Emergency Shutdown input**

- DN [B6] = 0
- Non-voltage contacts
- Open: Normal operation
- Close: Emergency shutdown

**CAUTION**

- Be sure to prepare a non-voltage continuous contact for each terminal.
- Supplementary Insulation must be added to user touchable part of switches.

**Electrical safety checks**

The electrical safety checks must be completed before turning on the electrical supplies to the Air to Water heat pump system. The electrical safety checks should be completed by a qualified electrician. All results measured should comply with your local/national electrical installation regulations.

**Earth continuity test**

On completion of the electrical installation a resistance test should be completed on the earth conductor to ensure continuity between all pieces of equipment on the earth conductor.

**Insulation resistance test**

This test must be completed using a 500 V D.C. insulation resistance tester. Insulation resistance tests should be completed between each live terminal and earth.

**Second remote controller (option)****Installation place**

- Install the remote controller at a height of 1 to 1.5 m from the floor so that the average temperature in the room can be detected.
- Do not install the remote controller in a place exposed to direct sunlight or direct outside air, such as the side of a window.
- Do not install the second remote controller in a location where the air flow around the remote controller is restricted.
- Do not install the remote controller in a freezing box or refrigerator, as the remote controller is not waterproof.
- Install the remote controller vertically to the wall.

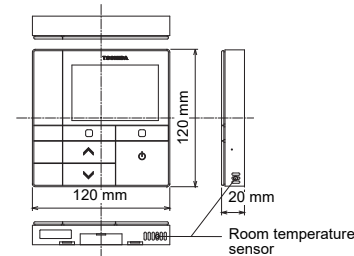
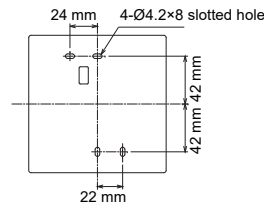
**Installation dimension**

**Remote controller installation**

**NOTE**

- Wiring for the remote controller should not be bundled or installed in the same conduit with a power cable.; otherwise, malfunction may result.
- Install the remote controller away from sources of electrical interference and electromagnetic fields.

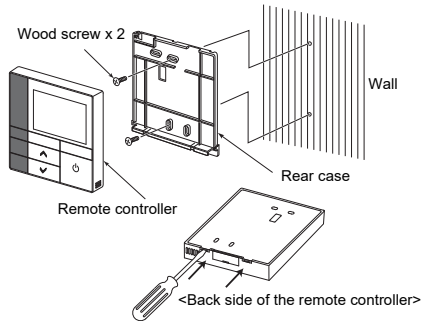

1. Insert a flat-blade screwdriver into the groove on the back side of the remote controller to remove the rear case.
2. Use the wood screws (2 pieces) supplied with the remote controller to attach the rear case of the remote controller to the wall. Do not use an electrical screwdriver. Do not over-tighten the screw (Tightening torque is up to 2 kg / f•cm.); otherwise, the rear case may be damaged.
3. Connect the electrical wire from the Hydro Unit to the terminal block of remote controller. (Refer to “Wire the remote controller”.)  
**Check the terminal number of electrical wire from the Hydro Unit to avoid miswiring. (If AC 220-240 V is applied, the remote controller and Hydro Unit will break down.)**

**Wire the remote controller**

**Wiring diagram**

Terminal block (TB04) for the remote control wiring on the Hydro Unit

- To control room temperature instead of water temperature with this remote controller, set DN “40” of Hydro Unit to “1”.

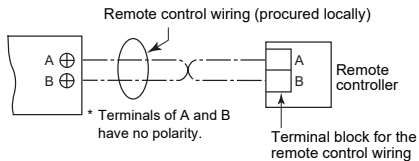

- \* Use wire of 0.5 mm<sup>2</sup> to 2.0 mm<sup>2</sup>.
- \* A crimp-style terminal cannot be used.

**Second remote controller installation requirements**

**Installation**

For a dual remote controller system, install the remote controllers in the following way.

1. Set one of remote controllers as the header remote controller. (Remote controller of Hydro Unit is preset as Header.)
2. Set from “Header / Second” in “Initial setting” on the setting screen.

**Basic wiring diagram**

**NOTE**

Terminals of A and B have no polarity.

**To diverge from the Hydro Unit**

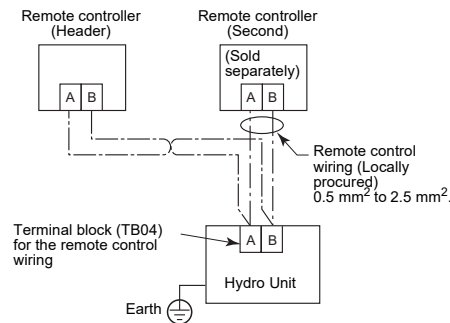

**Central Remote Controller (option)**

**To connect the Central Controller and BMS (TU2C-LINK)**

**CN902 for the central remote control wiring on the Hydro Unit PCB**

Communication wiring and central control wiring use 2-core non-polarity wires. Use 2-core shield wires to prevent noise trouble.

In this case, for the system grounding, close (connect) the end of shield wires, and isolate the end of terminal.

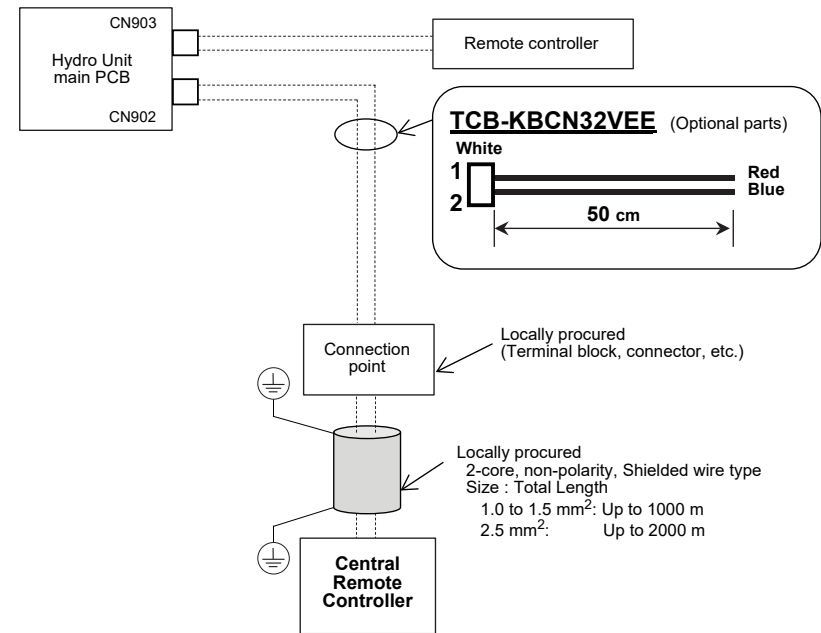

When connecting and controlling the system controller, the central control address (DN03) setting is required. On some system controllers, DN03 may be set automatically.

For details, refer to the manual of the system controller used and the installation manual.

Item	DN	Details
Central control address	03	1 ~ 128

### ■ 0-10V interface [HWS-IFAIP01U-E] (option)

#### To connect the 0-10V interface

##### TB04 for the 0-10V interface wiring on the Hydro Unit E-BOX

- Communication wiring use 2-core non-polarity wires.
- Use 2-core shield wires to prevent noise trouble.
- In this case, for the system grounding, close (connect) the end of shield wires, and isolate the end of terminal.
- Be sure not input more than DC10V to the analogue input terminals.
- The remote controller line (AB line) is available to connect a maximum of 2 units.  
For example the Header plus the second remote controller or the KNX or the MODBUS or the Wireless Adapter or the 0-10 V controller.

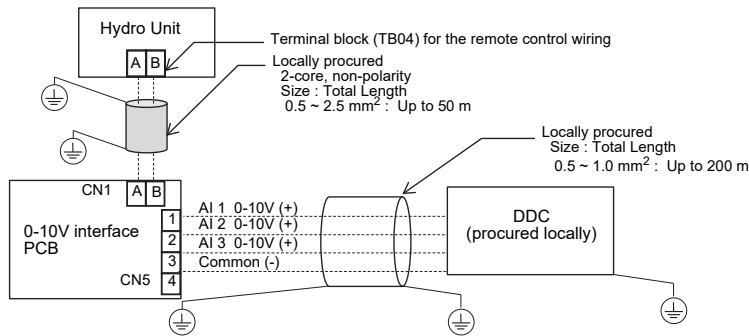

This option allows Hydro Unit to be controlled either Setting temperatures or Capacity.

#### Control of Setting temperature

- DN 680 is set to "1".
- Set the input method for each setting temperature.

DN	Item	Selectable value (Input from)
681	Hot water setting temperature.	0:Not use AI 1: AI 1 2: AI 2 3: AI 3
682	Zone 1 setting temperature for heating.	0:Not use AI 1: AI 1 2: AI 2 3: AI 3
683	Zone 2 setting temperature for heating.	0:Not use AI 1: AI 1 2: AI 2 3: AI 3
684	Zone 1 setting temperature for cooling.	0:Not use AI 1: AI 1 2: AI 2 3: AI 3

RC : Remote controller

- Allocate the temperature of 0 to 10V, and also set its resolution.

\*( ) : HWT-110

DN	Item	Selectable value
685	Upper limit of hot water setting temp. (at voltage level 16)	40 to 65 Default: 65°C
689	Resolution of hot water setting temp. (Value per voltage level)	1 to 5 Default: 5°C
686	Upper limit of Zone 1 setting temperature for heating (at voltage level 16)	20 to 55 (65) Default: 55°C
68A	Resolution of Zone 1 setting temperature for heating (Value per voltage level)	1 to 5 Default: 3°C
687	Upper limit of Zone 2 setting temperature for heating (at voltage level 16)	20 to 55 (65) Default: 55°C
68B	Resolution of Zone 2 setting temperature for heating (Value per voltage level)	1 to 5 Default: 3°C
688	Upper limit of Zone 1 setting temperature for cooling (at voltage level 16)	7 to 25 Default: 20°C
68C	Resolution of Zone 1 setting temperature for cooling (Value per voltage level)	1 to 5 Default: 1°C

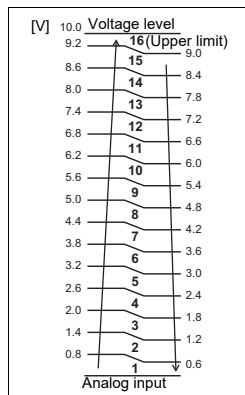

#### Capacity direct control

- DN 680 is set to "2, 3 or 4".

DN [680]	0	1	2	3	4
AI 1	Not use	Control of Setting temperature Enter settings from DN 681 to 684	Capacity direct control of HP operation for Heating/ Cooling mode	Not use	Capacity direct control of HP operation for Heating/ Cooling mode
AI 2			Not use	Capacity direct control of HP operation for Hot water mode	Capacity direct control of HP operation for Hot water mode
AI 3			Not use	Not use	Not use

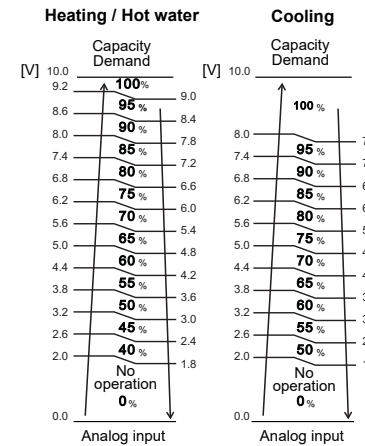

#### • DN 680 = 2

Analog input enable only for Heating or cooling mode.

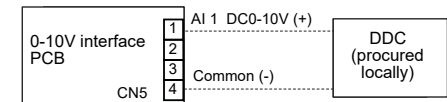

#### • DN 680 = 3

Analog input enable only for Hot water mode.

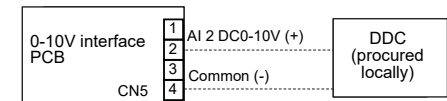

#### • DN 680 = 4

Analog input enable for Heating/Cooling and Hot water mode.

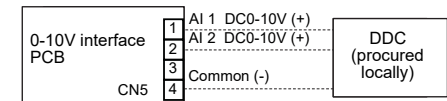

# 8 Group control and optional controllers

## To operate a group control of multiple Hydro Units

- Hydro Units are available to connect maximum 8 units.
- The wiring of remote controller on the Hydro Unit No.2 to No.8 should be disconnected as shown Fig.8-01.
- When the power supply has been turned ON, the automatic address setup starts and the address that is being setup flashes on the remote controller display in approximately 3 minutes. During the setup of the automatic address, the remote controller operation is not accepted.

**Required time up to the finish of automatic addressing is approximately 5 minutes.**

Please make sure all the DN codes in regard to the operation mode with the same setup.

- The remote Controller line (AB line) is available to connect maximum 2 units. Header plus Second Remote controller or KNX or MODBUS or Wireless Adapter or 0-10V controller.

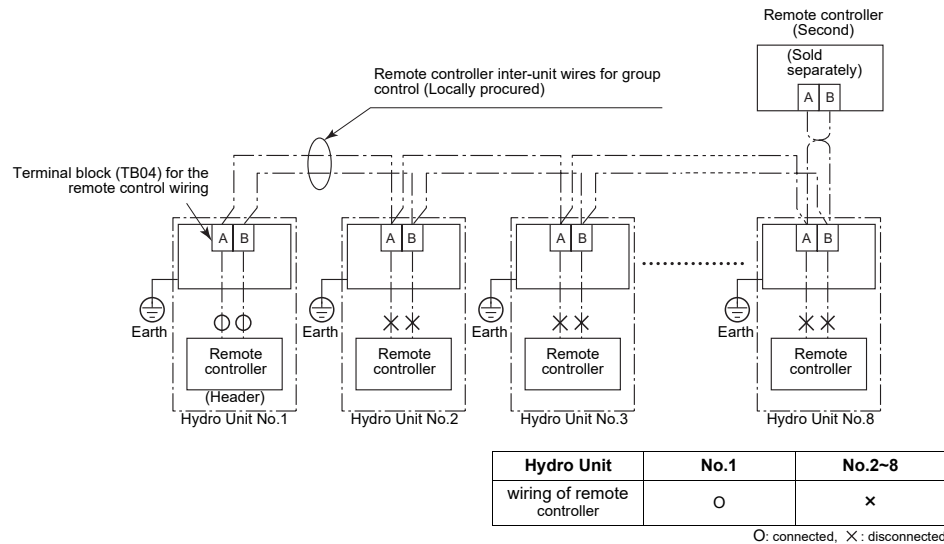

▼ Fig.8-01

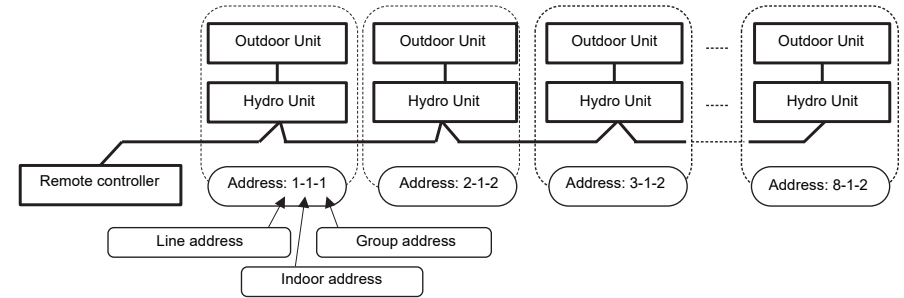
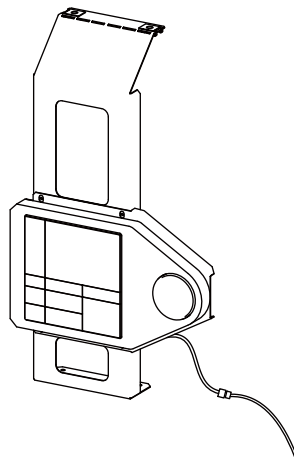

Item	DN	Details
Line address	12	1 ~ 128
Indoor address	13	1: Default ( 1 ~ 128 )
Group address	14	0: Individual (Not Group control) 1: Header unit 2: Follower unit

**NOTE**

The above address is set by automatically when the power is turned on. However, Line Address and Group Address are set randomly. In some cases, it is necessary to change the address manually after setup of the automatic address according to the system configuration of the group control.

**Group control**

- When Group control is used, the Slave Hydro Unit is also able to share the value of the Master Hydro Unit TTW sensor. In this case TTW Connection of each Slave Hydro Unit is not necessary.
- Set "DN AB" of each Slave Hydro Unit to "1".

## 9 Start up and configuration

Select "Hydro Unit DN" in the FIELD SETTING MENU to change the Hydro DN codes.  
Set the following initial settings and the other setting items. (Refer to page 28)

### ■ Setting Hydro DN codes

DN code	DN Description	Default	After Commissioning	Change 1	Change 2	Change 3
6B0	Used to activate external boiler output. 0 = external boiler output de-activated; 1 = external boiler output activated	0				
6B1	Boiler install location 0 = Heating side after 3 way valve 1 = Before 3 way valve	0				
6B2	Used to when an external cylinder thermostat is connected 0 = No external cylinder thermostat; 1 = External tank thermostat connected	0				
6B3	Used to when an external room thermostat is connected 0 = No external room thermostat; 1 = External room thermostat connected	0				
6B4	Used to determine type of 3 way diverting valve used on system. 0 = 2 wire/spring return or SPST type valve; 1 = SPDT type valve	0				
6B5	Synchronisation of Pump P2. 0 = P2 continuous operation (pump off when remote controller switched off) 1 = Pump P2 off during heating and cooling mode is off or hot water HP operation.	1				
6B8	Used when a hot water cylinder is connected to system. 0 = hot water cylinder connected; 1 = hot water cylinder not connected	0				
6B9	Used to activate Zone 1 Operation. 0 = Zone 1 activated; 1 = Zone 1 de-activated	0				
6BA	Used to activate Zone 2 Operation. 0 = Zone 2 de-activated; 1 = Zone 2 activated	Model 1 zone : 0 2 zone : 1				
6D0	P1 Pump operation for heating 0 = Normally run 1 = Stopped at the outside temperature over 20 °C	0				
6D1	Pump P1 power of regular, When long-term thermooff. 0 = None operation 1 = regular power	0				
6D2	Used to activate Hydro Unit back up heaters. 0 = Back up heaters activated; 1 = back up heaters de-activated	0				
6D3	Used to activate hot water cylinder electrical heater. 0 = hot water cylinder heater activated; 1 = hot water cylinder heater de-activated	0				
6D4	Used to activate external booster heater output. 0 = external booster heater output activated; 1 = external booster heater output de-activated	0				
28	Used to activate system auto restart after power failure. 0 = auto restart activated; 1 = auto restart de-activated	0				
5A	P1 Pump operation for hot water 0 = synchronised with heat pump 1 = Normally run	0				
B6	Used to activate SG Ready control 0 = SG Ready control de-activated 1 = SG Ready control activated	0				

### ■ Names and functions of parts

#### Buttons

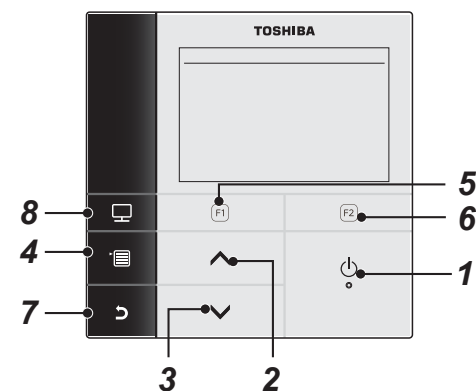

**1** [ ] **ON/OFF** button

**2** [ ] button

On the top screen: Adjusts the temperature.

On the menu screen or other screen: Selects a menu item or ON/OFF of each function or moves a cursor, etc.

**3** [ ] button

On the top screen: Adjusts the temperature.

On the menu screen or other screen: Selects a menu item or ON/OFF of each function or moves a cursor, etc.

**4** [ ] **MENU** button

On the top screen: Displays the "MENU" screen.

On the other screen: Fixes or copies setting the parameter value.

**5** [ ] button

On the top screen: Select the heating or cooling mode.

On the other screen: Varies its function according to the screen.

**6** [ ] button

On the top screen: Select the hot water mode.

On the other screen: Varies its function according to the screen.

**7** [ ] **RETURN** button

Returns to the previous screen, etc.

**8** [ ] **MODE** button

On the top screen: Select the mode for which to change the temperature.

On the other screen: Resets the setting parameter value.

## ■ Meaning of Indication on the top screen

### In normal

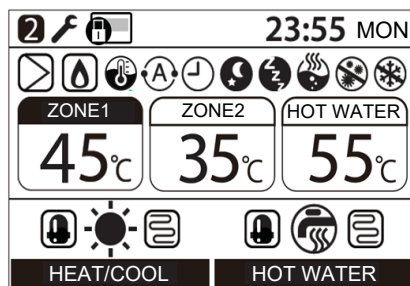

### In error occurring

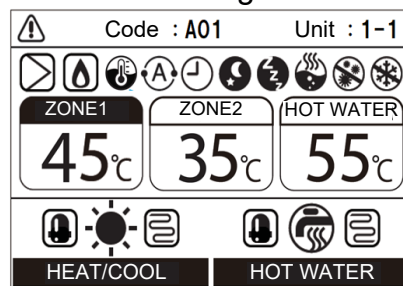

	Lights when floor heater or radiator is connected (when the system has floor heater or radiator).
	Lights when controlling the second temperature (It may not light depending on the system).
	Lights when hot water supply system is connected (when the system has hot water supply).
	The painted mark lights for operation mode for which temperature is to be changed.
	Lights when the compressor is acting for heating or cooling operation.
	Lights while the electric heater inside the Hydro Unit is energized during a heating operation.
	Lights while the compressor is acting for hot water supply operation.
	Lights while the electric cylinder heater is energized during hot water operation.
	Lights when heating is selected.
	Lights when cooling is selected.
	Lights during hot water supply is selected.
	Lights while internal water pump is driven.
	Lights when the auxiliary boiler or external booster heater supports the heat pump operation.
	Lights during water temperature control mode / room temperature control mode.
	Lights during Auto mode operation.
	Lights when Schedule timer or Floor drying is set to "ON".

	Lights when Night setback operation is set to "ON" and heating or cooling is selected.
	Lights while Silent mode operation is actually running.
	Lights while hot water boost is actually running.
	Lights when Anti bacteria operation is set to "ON" and hot water operation is selected.
	Lights while Frost protection operation is actually running.
	Lights when Test mode or Floor drying is set to "ON".
	Displays when the remote controller is set as Second remote controller.
	Lights when an error occurs and goes out when the error is cleared.
	Lights when operation is limited by central remote controller setting.

## ■ Menu operation

- (1) Press the [ ] button, then the "MENU" screen is displayed.
- (2) Press the [ ] / [ ] button to select an item. The selected item is highlighted.
- (3) Press the [ ] button. The setting screen appears.

To undo

Press the [ ] button to return. The display returns to the previous screen.

## ■ Menu items

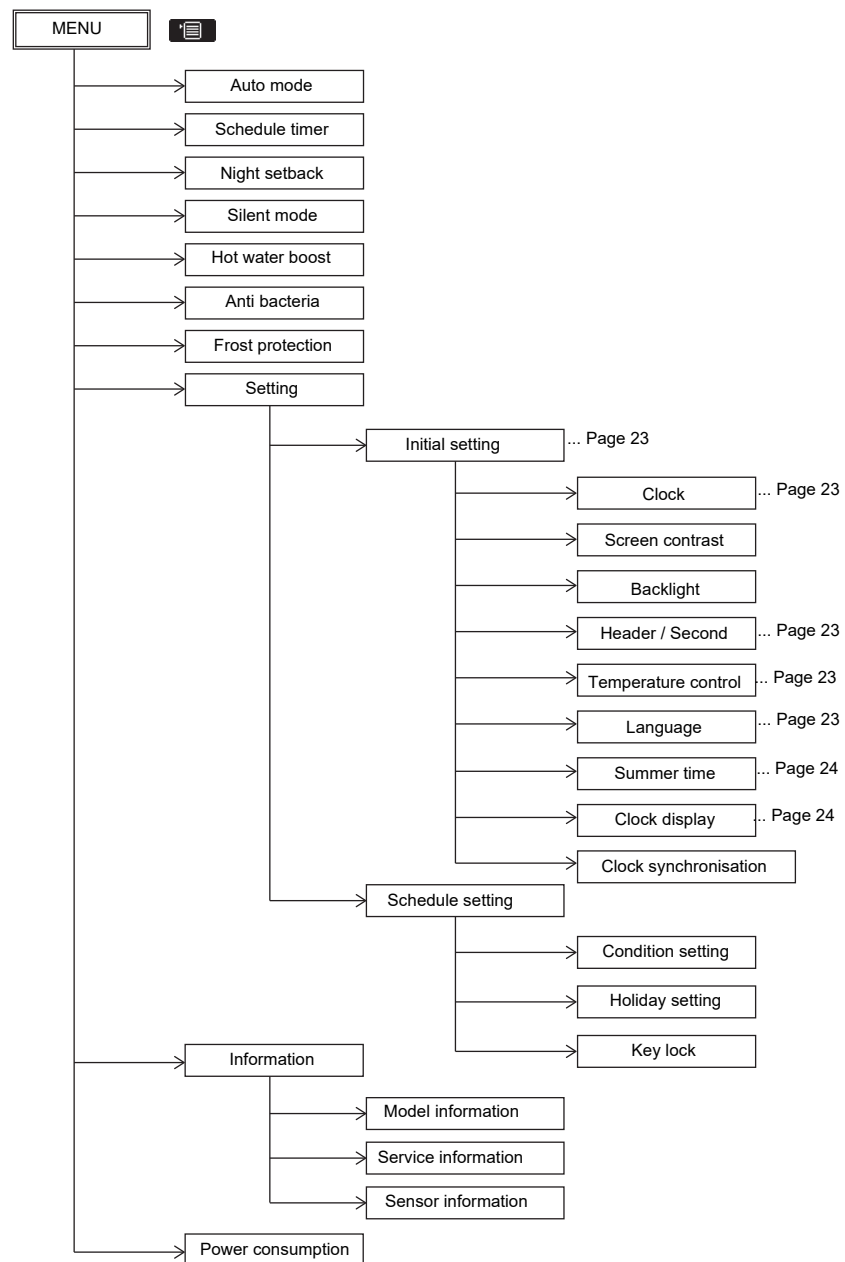

## ■ FIELD SETTING MENU items

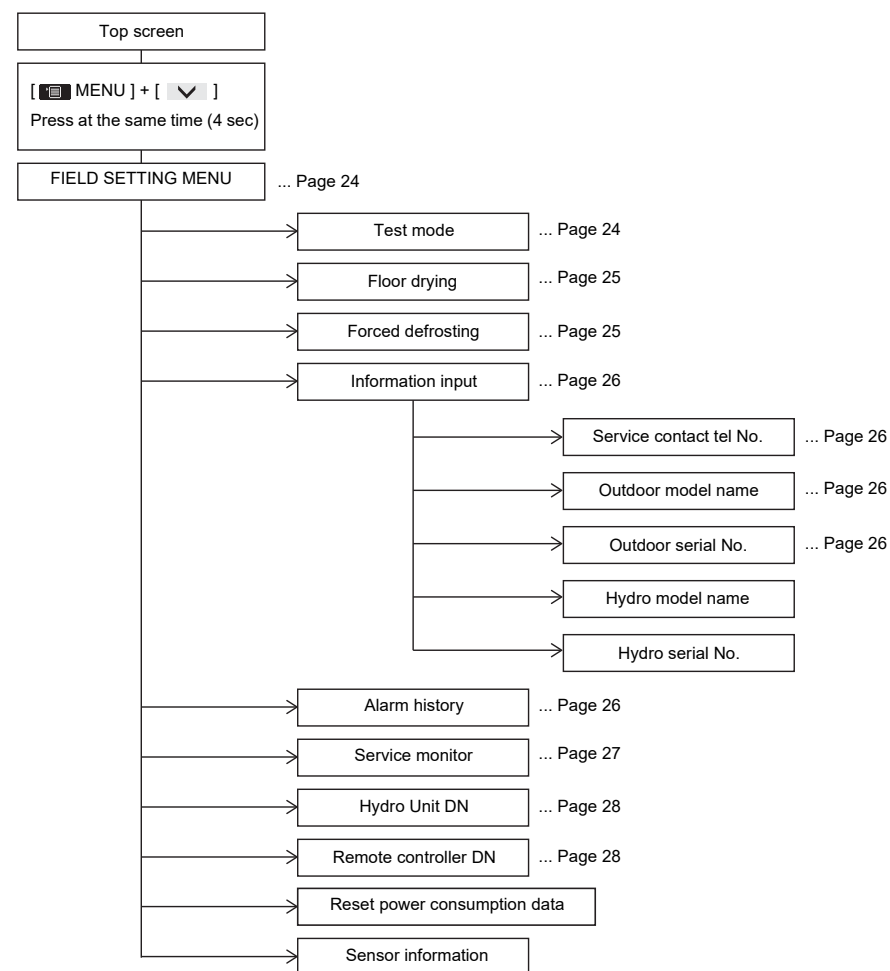

## ■ Setting – Initial setting –

- (1) Press the [ ]/[ ] button to select “Setting” on the “MENU” screen, then press the [ ] button.

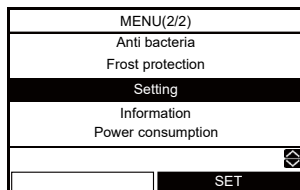

- (2) Press the [ ]/[ ] button to select “Initial setting” on the Setting screen, then press the [ ] button.

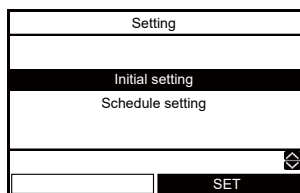

## ■ Clock

- Setting for the clock (date, month, year, time)

- (1) Press the [ ]/[ ] button to select “Clock” on the Initial setting screen, then press the [ ] button.

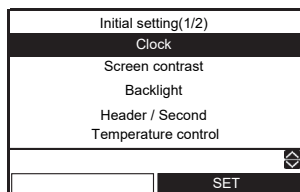

- (2) Press the [ ]/[ ] button to select the date, month, year, and, time.
- (3) Press the [ ]/[ ] button to set the value, then press the [ ] button.

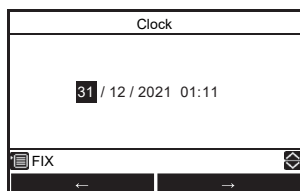

- The clock display appears on the top screen.
- The clock display blinks if the clock setting has been reset due to power failure or other cause.

## ■ Header / Second

- For a dual remote controller system.
- Set one of remote controller as the header remote controller.
- Set another remote controller as the second remote controller.

- (1) Press the [ ]/[ ] button to select “Header / Second” on the “Initial setting” screen, then press the [ ] button.

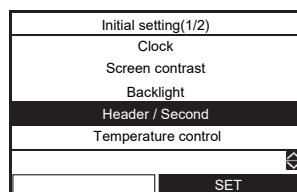

- (2) Press the [ ]/[ ] button to select “Header” / “Second”, then press the [ ] button.

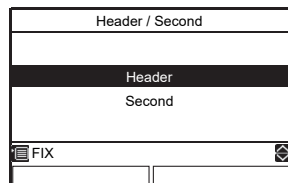

- Some function are not available when the remote controller is set as the Second remote controller.
- In the dual remote controller system, the latter operation overrides the former.
- The factory default is Header remote controller.

- Disable function with second remote controller
- “Schedule timer”
  - “Silent mode”
  - “Schedule setting”

## ■ Temperature control

- To control room temperature instead of water temperature with this remote controller

- (1) Press the [ ]/[ ] button to select “Temperature control” on the “Initial setting” screen, then press the [ ] button.

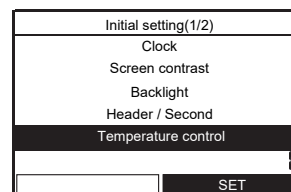

- (2) Press the [ ]/[ ] button to select “ON/OFF”, then press the [ ] button.

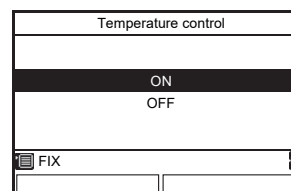

- When the “Temperature control” is set to “ON”, the system is controlled with the sensor of the remote controller.
- The factory default is “OFF”.

## ■ Language

- Select a language for the screen text.

- (1) Press the [ ]/[ ] button to select “Language” on the “Initial setting” screen, then press the [ ] button.

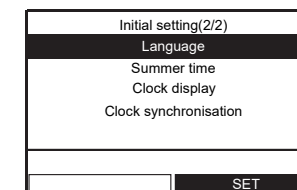

- (2) Press the [ ]/[ ] button to select the language, then press the [ ] button.

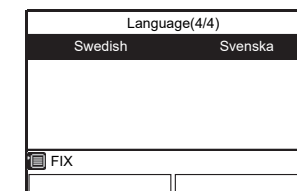
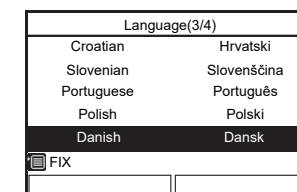
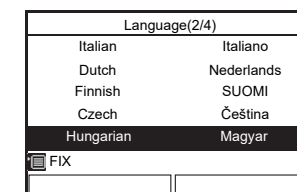
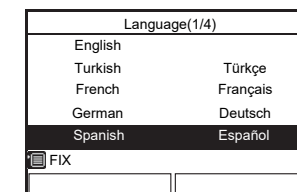

- The factory default is “English”.



## ■ Summer time

- Set summer time (Daylight saving time).
- When This function is "ON" and the time in "Start date" is reached, the setting time in the remote controller shifts by +1 hour (e.g. 1:00→2:00), and when the time in "End date" is reached, the setting time shifts -1 hour (e.g. 1:00→12:00).
- The scheduled time itself of the following functions are not changed.

Schedule timer, Night setback, Silent mode, Anti bacteria

The operation starts according to the shifted time.

If a schedule is set within 1 hour before and after Summer time Start and End time, there may be cases that the operation is repeated or skipped on the date.

- (1) Press the [ ] / [ ] button to select "Summer time" on the "Initial setting" screen, then press the [ ] button.

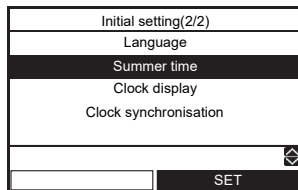

- (2) Press the [ ] / [ ] button to select "ON" on the "Summer time" screen, then press the [ ] button.

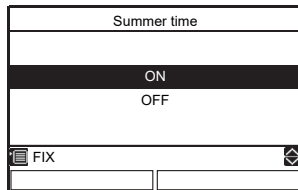

- (3) Press the [ ] / [ ] button to change the start date and the end date, then Press the [ ] / [ ] button to set the day, month, time.

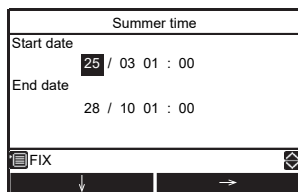

- (4) Press the [ ] button.

## ■ Clock display

- Select the clock display 12-hour clock or 24-hour clock on the top screen.
- Even if you select the 12-hour clock, the clock displays other than the top screen is 24-hour clock

- (1) Press the [ ] / [ ] button to select "Clock display" on the "Initial setting" screen, then press the [ ] button.

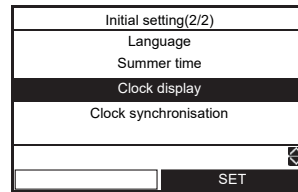

- (2) Press the [ ] / [ ] button to select "24H" / "AM/PM" on the "Clock display" screen, then press the [ ] button.  
"24H": 24-hour clock  
"AM/PM": 12-hour clock

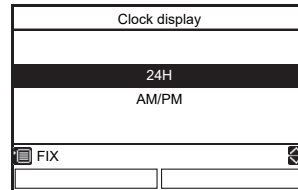

## ■ Clock synchronisation

- Set clock synchronisation.
- When this function is "ON" and clock setting is changed in central controller, clock setting will be changed automatically.

- (1) Press the [ ] / [ ] button to select "Clock synchronisation" on the "Initial setting" screen then press the [ ] button.

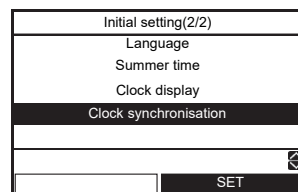

- (2) Press the [ ] / [ ] button to select "ON" on the "Clock synchronisation" screen, then press the [ ] button.

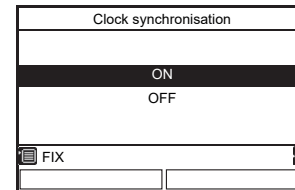

## ■ FIELD SETTING MENU

- (1) Press the [ ] button and the [ ] button at same time for 4 seconds or longer on the top screen to display the "FIELD SETTING MENU screen" to select "setting"

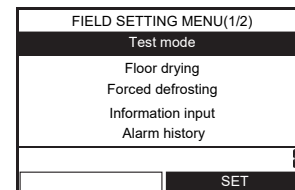

## ■ Test mode

- Even if the outside air temperature or water temperature is outside the setting value range, Heating, Cooling and Hot water supply operation become possible.
- Since the protection setting is disabled in the "TEST mode", do not continue a test run longer than 10 minutes.

- (1) Press the [ ] / [ ] button to select "Test mode" on the "FIELD SETTING MENU" screen, then press the [ ] button.

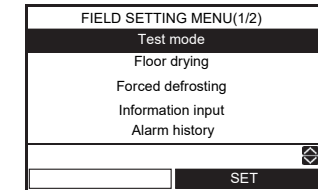

- (2) Press the [ ] button to select "ON", then press the [ ] button. The mark appears on the top screen.

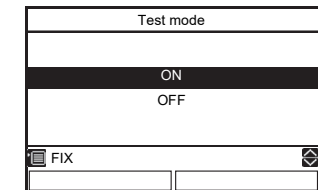

- (3) Start the heating or cooling or Hot water operation on the top screen, then the selected mode mark is blinking during "Test mode".

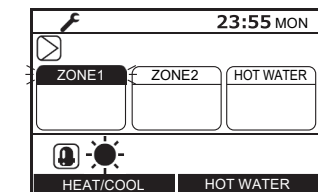

- The pump is activated in 30 seconds. If air is not released completely, the flow rate switch is activated to stop operation. Release air again according to the piping procedure. Little air entrainment is discharged from the purge valve.
- Check that the hydraulic pressure has become the predetermined pressure 0.05 MPa (0.5 bar). If the hydraulic pressure is insufficient, replenish water.
- Heating operation starts. Check that the Hydro Unit starts heating.
- Press the [F1] button to select the Cooling operation, in a few second, the operation starts.
- Check that the Hydro Unit starts cooling and that the floor heating system is not cooled.
- Press the [F1] button to stop the operation.
- Press the [F2] button to start the Hot water supply operation.
- Check that there is no air entrainment.
- Check that hot water is present at the connection port of the hot water cylinder.
- Press the [F2] button or [ON/OFF] button to stop the operation.

## ■ Floor drying

- This function is available only for the header remote controller.
- This function is used for drying concrete etc.
- Operation by second remote controller is limited during floor drying.
- Operation may be restricted depending on the setting of the central remote controller.
- Service personnel must operate the unit after setting the related DN.
- Operation is not started unless All the related DN are set.
- Refer to the following for the settings of the related items. Please setup on the responsibility for an installer. An unsuitable setup may cause a crack of concrete etc.
- When the operation starts, the unit operates as follows.

- Press the [▲] / [▼] button to select "Floor drying" on the "FIELD SETTING MENU" screen, then press the [F1] button for 4 seconds or longer.

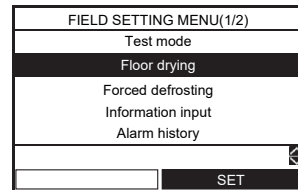

- DN: 14 setting start and End temperature [20-55°C]  
 DN: 15 setting Max temperature [20-55°C]  
 DN: 16 continuation days for every step up to Max temperature [1-7 days]  
 DN: 17 temperature difference for every step up to Max temperature [1-10 K]  
 DN: 18 continuation days for every step down to End temperature [1-7 days]  
 DN: 19 temperature difference for every step down to End temperature [1-10 K]  
 DN: 1A Continuation days in Max temperature [1-50 days]

setting temperature

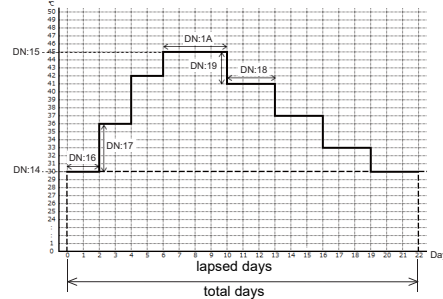

- Press the [F1] / [F2] button to select "DN" or "Data", then press the [▲] / [▼] button to set the value.

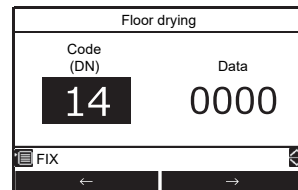

- Press the [F1] button. The set value is registered.

### To start the operation

- Press the [▲] / [▼] button to select "Floor drying" on the "FIELD SETTING MENU" screen, then press the [F2] button.

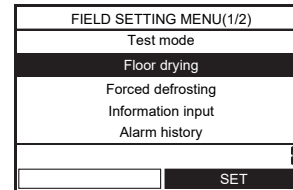

- Press the [▲] button to select the "ON", then press the [F1] button.

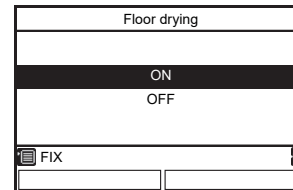

- Check the total days for "Floor drying" operation, then press [F1] button. The wrench mark and clock mark appears on the Top screen.
- Start the heating operation on the top screen.
- Then "ZONE1" mark blinks during "Floor drying" operation and lapsed days are displayed.

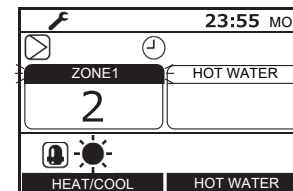

- If some abnormalities occur during Floor drying operation, the System stops and Alarm history screen is displayed.
- After heating operation is stopped by operating the remote controller during Floor drying operation, if heating operation is again started within 30 minutes, Floor drying operation is started from the time of stopping.

## ■ Forced defrosting

- This function is available only for the header remote controller.
- This function can active the forced defrosting mode for the Outdoor Unit.

- Press the [▲] / [▼] button to select "Forced defrosting" on the "FIELD SETTING MENU" screen, then press the [F2] button.

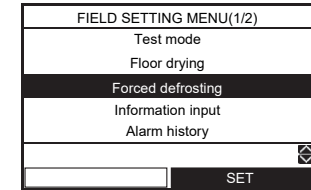

- Press the [▲] button to select "ON", then press the [F1] button.

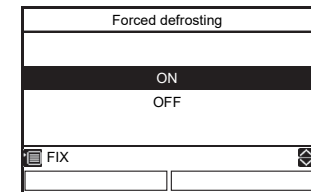

- Start the heating operation on the top screen.

## Information input

- Register information about the contact number for Service, model name and serial number of the Hydro Unit and Outdoor Unit.

- Press the [ ] / [ ] button to select "Information input" on the "FIELD SETTING MENU" screen, then press the [ ] button.

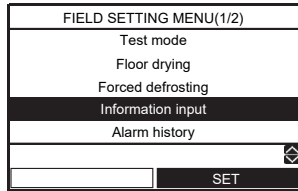

### Service contact tel No.

- Press the [ ] / [ ] button to select "Service contact tel No." on the Information input screen, then press the [ ] button.

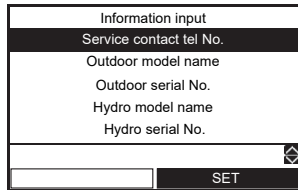

- Press the [ ] / [ ] button or [ ] / [ ] to select the value, then press the [ ] button.

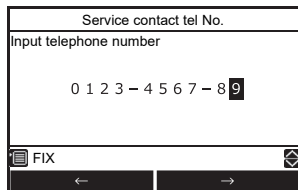

### Outdoor (Hydro) model name Outdoor (Hydro) Unit serial No.

- Press the [ ] / [ ] button to select "Outdoor model name (Hydro model name, Outdoor serial No., Hydro serial No.)" on the Information input screen, then press the [ ] button.

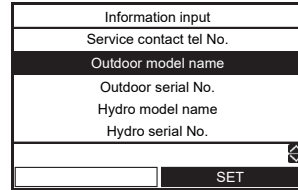

- Press the [ ] / [ ] button to select registration menu.

When you enter the model name (serial No.) by yourself, select "Manual model name input" ("Manual serial No. input")

Press the [ ] / [ ] button or [ ] / [ ] to select the character (the selected character is highlighted), then press the [ ] button. The character is displayed on the upper part of the screen from left-hand side.

If the [ ] button is pressed in the state where "Del" is selected, contents currently displayed is deleted from right-hand side.

Press the [ ] button in the state where "Fix" is selected to register contents currently displayed on the upper part of the screen.

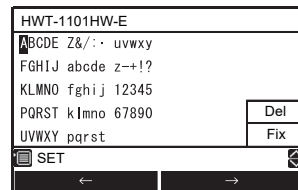
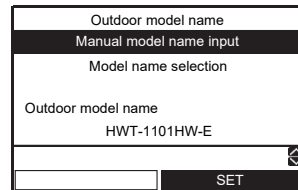

Select "Model name selection", then press [ ] button. And, select "Remote controller", then press [ ] button.

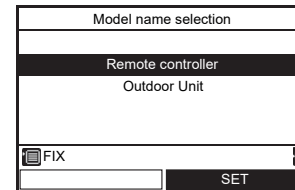
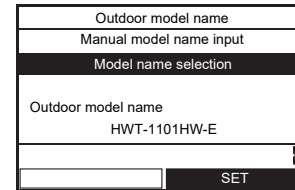

When you select "Outdoor Unit" ("Hydro Unit") in model name selection screen, factory default value will be displayed in information screen.

•After Information input has been finished, confirm the item "Information" on the "MENU" screen to check the information is registered correctly.

## Alarm history

- List of latest 10 alarm data: error information of error code, date and time is displayed.

- Press the [ ] / [ ] button to select "Alarm history" on the "FIELD SETTING MENU" screen, then press the [ ] button.

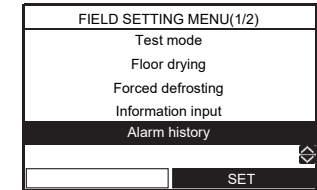

### To reset the alarm history

- Press the [ ] button to reset the alarm history.

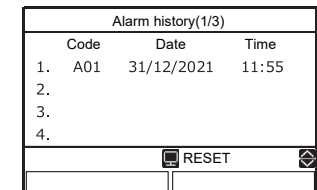

- Press the [ ] button, then all alarm data is cleared.



### Service monitor

- The sensor sensing temperature is displayed on the remote controller.
- This function allows you to make sure whether the sensor is installed properly.

(1) Press the [ ] / [ ] button to select "Service monitor" on the "FIELD SETTING MENU" screen, then press the [ ] button.

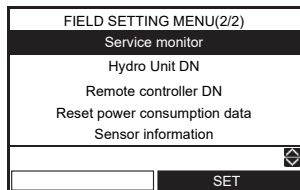

(2) Press the [ ] button to select the unit, then press the [ ] button to display the status.

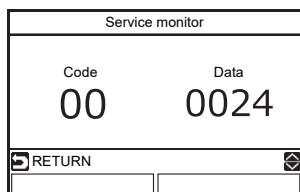
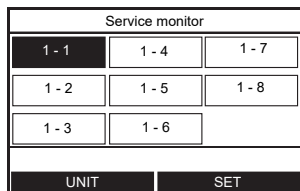

code	Data name	Unit
00	Control temperature (Hot water cylinder)	°C
01	Control temperature (Zone1)	°C
02	Control temperature (Zone2)	°C
03	Remote controller sensor temperature	°C
04	Condensed temperature (TC)	°C
06	Water inlet temperature (TWI)	°C
07	Water outlet temperature (TWO)	°C
08	Water heater outlet temperature (THO)	°C
09	Floor inlet temperature (TFI)	°C
0A	Hot water cylinder temperature (TTW)	°C
0B	Mixing valve position	step
0E	Low pressure (Ps) × 1/10	kPa
0F	Hydro soft ver.	-

code	Data name	Unit
60	Heat exchange temperature (TE)	°C
61	Outside air temperature (TO)	°C
62	Discharge temperature (TD)	°C
63	Suction temperature (TS)	°C
65	Heat sink temperature (THS)	°C
6A	Current × 10	A
6D	Heat exchanger coil temperature (TL)	°C
70	Compressor operation Hz	Hz
72	Number of revolutions of outdoor fan (lower or 1 fan model)	rpm
73	Number of revolutions of outdoor fan (upper)	rpm
74	Outdoor PMV position × 1/10	pls
7A	Discharge pressure (PD) × 1/10	kPa

code	Data name	Unit
F0	Micro computer energized accumulation time × 1/100	h
F1	Hot water compressor ON accumulation time × 1/100	h
F2	Cooling compressor ON accumulation time × 1/100	h
F3	Heating compressor ON accumulation time × 1/100	h
F4	Built-in AC pump operation accumulation time × 1/100	h
F5	Hot water cylinder heater operation accumulation time × 1/100	h
F6	Backup heater operation accumulation time × 1/100	h
F7	Booster heater operation accumulation time × 1/100	h

- Some sensors (temperature / pressure) are not displayed, because not connected.

### Reset power consumption data

(1) Press the [ ] / [ ] button to select "Reset power consumption data" on the "FIELD SETTING MENU" screen, then press the [ ] button.

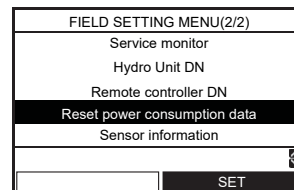

(2) Press the [ ] button, then power consumption data is cleared.

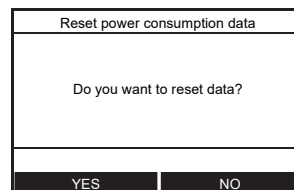

### Sensor information

(1) Press [ ] / [ ] button to select "Sensor information" on the "FIELD SETTING MENU" screen, then press the [ ] button.

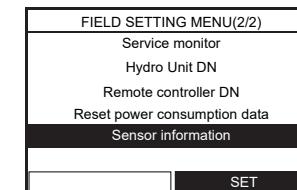

(2) Select display number.

- Display 1 is Hydro Unit sensor
- Display 2 is Outdoor Unit sensor

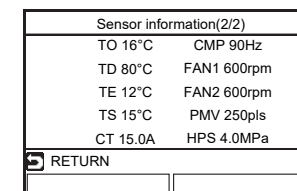
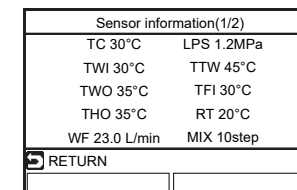

## Hydro Unit DN (Remote controller DN)

- Hydro Unit DN setting is available only for the header remote controller.
- Set DN for various operation modes with the remote controller.

(1) Press the [  $\uparrow$  ] / [  $\downarrow$  ] button to select "Hydro Unit DN" (or "Remote controller DN") on the "FIELD SETTING MENU" screen, then press the [ F2 ] button.

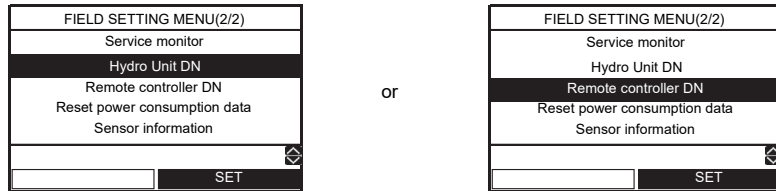

(2) Press the [ F1 ] / [ F2 ] button to select "DN" or "Data", then press the [  $\uparrow$  ] / [  $\downarrow$  ] button to set the value.

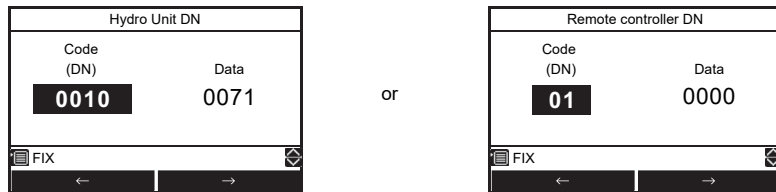

(3) Press the [  $\text{FIX}$  ] button. The set value is registered.

## Main setting items

### (1) Setting Temperature Range (DN 18 to 1F)

- Set the temperature range for heating (zone 1, zone 2), cooling, and hot water.
- The upper-limit and lower-limit temperatures of each mode can be set.

### (2) Setting Heat Pump Operation Conditions for Hot Water Supply (DN 20 and 21)

- Set the heat pump start water temperature and heat pump stop water temperature.
- The heat pump starts working when the water temperature lowers below the set start water temperature. It is recommended that the default value be used.

### (3) Compensating Hot Water Temperature (DN 24 and 25)

- Compensate the target temperature from the remote controller set temperature when the hot water temperature lowers below the set outside air temperature.

### (4) Setting Hot Water Boost (DN 08 and 09)

- Set the control time and target temperature when the HOT WATER BOOST is operated.

### (5) Setting Anti-Bacteria

- Set the control for the hot water cylinder when ANTI BACTERIA is operated.
- Set the target temperature, control period, start time (24-hour notation), and target temperature retention period.
- Make this control setting according to regulations and rules of respective countries.

### (6) Setting Priority Mode Temperature

- Set the outside air temperature that changes the preferred operation mode.
- Hot Water - Heating Switching Temperature Heating operation takes precedence when the temperature lowers the set temperature.
- Boiler HP Switching Temperature When the temperature lowers the set temperature the external boiler output is made.

### (7) Setting Heating Auto Mode Temperature (DN 27 to 31, A1 to A5)

- Compensate the target temperature when Auto is set for temperature setting on the remote controller.
- The outside air temperature (T0, T1 and T3) can be set individually.
- The target temperature can be set to a value from 20 to 55 °C.
- However,  $A > B > C > D > E$ .

▼ Fig.9-02  
<Zone 1>

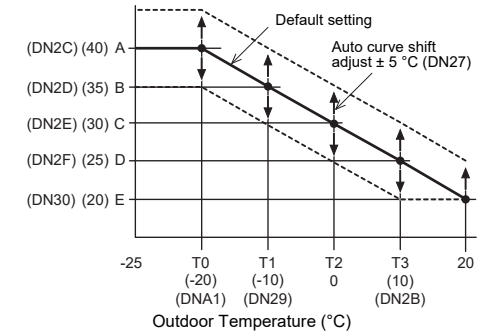

- The entire curve can be adjusted plus and minus 5 °C by DN27.

### <Zone 2>

You can choose either a percentage or a fixed value as the setting method of zone 2

DNA2 = "0" : percentage (DNA31)

DNA2 = "1" : fixed value (DNA3), (DNA4), (DNA5)

However, zone 1  $\geq$  zone 2

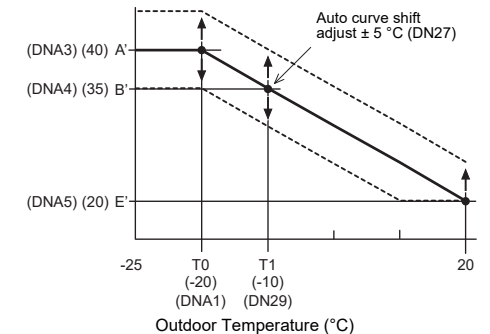

### (8) Setting Frost Protection Temperature (DN 3A to 3B)

- Set the function when the Frost protection is set to "ON".
- Set enabling/disabling of this function and the target water temperature.
- If disabling is set, the frost protection operation is not performed even when the Frost protection is set to "ON".

### (9) Setting Frequency of Output to Internal Heater (DN 33 to 34)

- The increase/decrease time is used to set the response time.

**(10)Setting Night Setback (DN 26. remote controller DN 0E to 0F)**

- Set the function when the Night setback is set to "ON".
- Set reduction temperature, start time, and end time.

**(12)Hydro 2-Way Diverting valve operation. control**

- When using both cooling and heating operations and there is an Hydro Unit only for heating (such as floor heating), install the 2-way valve and set this function code.

**(13)Setting 3way Valve Operation (DN 54)**

- This setting is not necessary for normal installation. Make this setting to invert the logic circuit in case ports A and B of the 3-way valve are wrongly attached and it cannot be rectified on site.

**(14)Mixing valve operation setting**

- Set the time period from full close to full open of the 2-zone control mixing valve. Set a value that is 1/10 of the actual time. And. setting the interval control time. (minutes)

**(15)Setting Heating/Hot Water Switching when Boiler Is Used (DN 3E)**

- When boiler is used, make this setting to operate the Hydro Unit by the instruction from the boiler.

**(16)Setting Heat Pump Operating Time for Hot Water Supply Operation**

- Set the time period from the start of heat pump run to the start of heater energization at the beginning of hot water supply operation. If a long period is set, it takes long time for heating water.

**(17)Setting Cooling "ON/OFF"**

- Set this function when performing cooling operation.

**(18)Remote controller time indication**

- 24-hour or 12-hour notation is selected for the timer.

**(19)Setting Silent Mode Operation**

- Issue an instruction for low-noise mode operation to the Outdoor Unit. Enabling/ disabling of this function, start time, and end time can be set.

**(20)Setting Alarm Tone**

- The remote controller alarm tone can be set.

**(21)Second Remote controller and room temperature thermostat**

- Set the initial temperature setting.

**(22)Selection of mode of operation by external input**

- Select the logic of an external input signal (option)

**(23)Hydro Unit Capacity setting**

**(24)Second Remote controller target temperature setting**

**(25)Room temperature sensor setting**

**(26)Synchronisation control at low outside temperature**

**(27)P1 pump speed control**

**(28)Restriction of backup heater energization during heating mode. (For energy saving)**

- When outdoor temperature is higher than the reference value, the backup heater is forcibly off during heating mode.
- Default : No restriction (Same as the conventional control)

**(29)Interval operation of the pump during thermostat off operation (For energy saving)**

- The pump of the Hydro Unit performs intermittent operation according to the outdoor temperature during thermostat off (compressor off) operation.
- Default : Continuous operation (Same as the conventional control)

**(30)Backup heater energization control during defrosting (For energy saving)**

- When the heater outlet temperature (THO) drops 2K below the TSC\_F -  $\beta$ , the backup heater (3 kW) is energized. TSC\_F is the assigned temperature with the remote controller.

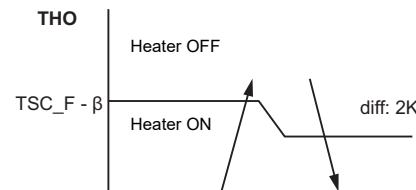

- Default:  $\beta = 0$  (Same as the conventional control)

**(31)"Floor drying"**

- Please refer to the item of "FIELD SETTING MENU"

**(32)Group control**

- Slave Hydro Units can use the TTW value transmitted from the Master Hydro Unit.

**DN settings**

	DN Description	Location & DN Number		Range HWT-60 (HWT-110)	Default HWT-60 (HWT-110)	After Commissioning	Change 1	Change 2
		Hydro	RC					
1	Setting Temperature Range	Heating Upper Limit - Zone 1	1A	-	37~55 °C (65 °C)	55 (65)		
		Heating Lower Limit - Zone 1	1B	-	20~37 °C	20		
		Heating Upper Limit - Zone 2	1C	-	37~55 °C (65 °C)	55 (65)		
		Heating Lower Limit - Zone 2	1D	-	20~37 °C	20		
		Cooling - Upper Limit	18	-	18~30 °C	25		
		Cooling - Lower Limit	19	-	7~20 °C	7		
		Hot Water - Upper limit	1E	-	60~65 °C	65		
	Hot Water - Lower limit	1F	-	40~60 °C	40			
2	Hot Water Operation	Heat Pump Start Temperature	20	-	20~45 °C	38		
		Heat Pump Stop Temperature	21	-	40~65 °C	52		
3	Hot Water Temperature Compensation	Temperature Compensation Outside Air Temperature (°C)	24	-	-20~10 °C	0		
		Compensation Temperature (°C)	25	-	0~15 °C	3		
4	Hot Water Boost	Operation Time (x10 min)	08	-	3~18	6		
		Setting Temperature (°C)	09	-	40~65 °C	65		
5	Anti Bacteria	Setting Temperature (°C)	0A	-	60~65 °C	65		
		Start Cycle (Day)	-	0D	1~10	7		
		Start Time (Hour)	-	0C	0~23	22		
	Operation Time (min)	0B	-	0~60	30			
6	Priority Mode	Boiler & Heat Pump Switching Temperature (°C)	23	-	-20~20	-10		
7	Heating Auto Curve Settings	Outside Temperature T0 (°C)	A1	-	-20 (-30)~ -15 (-20) °C	-20		
		Outside Temperature T1 (°C)	29	-	-15~0 °C	-10		
		Outside Temperature T2 (°C)	-	-	0	0		
		Outside Temperature T3 (°C)	2B	-	0~15 °C	10		
		Setting Temperature A at T0 (°C) - ZONE 1	2C	-	20~55 °C (65 °C)	40		
		Setting Temperature B at T1 (°C) - ZONE 1	2D	-	20~55 °C (65 °C)	35		
		Setting Temperature C at T2 (°C) - ZONE 1	2E	-	20~55 °C (65 °C)	30		
		Setting Temperature D at T3 (°C) - ZONE 1	2F	-	20~55 °C (65 °C)	25		
		Setting Temperature E at 20 °C (°C) - ZONE 1	30	-	20~55 °C (65 °C)	20		
		ZONE2 temperature setting 0 = Percentage (FC 31) 1 = Fixed value (FCA3~A5)	A2	-	0~1	0		
		Ratio Of Zone 2 In Zone 1 Auto Mode (%)	31	-	0~100%	80		
		Setting Temperature A' at T0 (°C) - ZONE 2	A3	-	20~55 °C (65 °C)	40		
		Setting Temperature B' at T1 (°C) - ZONE 2	A4	-	20~55 °C (65 °C)	35		
		Setting Temperature E' at 20 °C (°C) - ZONE 2	A5	-	20~55 °C (65 °C)	20		
		Auto Curve - Temperature Shift (°C)	27	-	-5~5 °C	0		

		Location & DN Number		Range HWT-60 (HWT-110)	Default HWT-60 (HWT-110)	After Commissioning	Change 1	Change 2
DN Description	Hydro	RC						
8	Frost Protection	Function 0 = Invalid; 1 = Valid	3A	-	0~1	1		
		Frost Protection Setting Temperature (°C)	3B	-	10~20 °C	15		
		End days	-	12	0~20	0		
		End times	-	13	0~23	0		
9	Back Up Heater Control	Downtime Back Up Heater 0 = 5min; 1 = 10min; 2 = 15min; 3 = 20min	33	-	0~3	1		
		Uptime Back Up Heater 0 = 10min; 1 = 20min; 2 = 30min; 3 = 40min	34	-	0~3	0		
10	Night Setback	Change Setback Temperature	26	-	3~20 °C	5		
		Zone selection 0 = Zone 1 & 2; 1 = Zone 1 Only	58	-	0~1	0		
		Start Time (Hour)	-	0E	0~23	22		
		End Time (Hour)	-	0F	0~23	06		
12	Hydro 2 Way Valve Operation Control	Cooling 2 Way Valve - Operation Logic 0 = Activated during cooling; 1 = Not activated during cooling	3C	-	0~1	0		
13	Hydro 3 Way Diverting Valve Operation Control	3 Way Diverting Valve Operation Logic 0 = Activated during hot water operation; 1 = not activated during hot water operation	54	-	0~1	1		
14	2 Zone Mixing Valve Drive Time	Specified Drive Time for Mixing Valve (x10sec)	0C	-	3~24	6		
		Mixing valve OFF (control time - mins)	59	-	1~30	4		
15	Boiler/Heat Pump Synchronisation	External Boiler/Heat Pump Synchronisation 0 = Synchronised; 1 = Not synchronised	3E	-	0~1	0		
16	Maximum Operation Time Of Hot Water Heat Pump	Maximum Heat Pump Operation Time In Hot Water Operation Priority Mode (minutes)	07	-	1~120	30		
17	Cooling Operation	0 = Cooling & Heating Operation; 1 = Heating Only Operation	02	-	0~1	0		
18	Remote controller Indication	24h or 12h Time Indication 0 = 24h; 1 = 12h	-	05	0~1	0		
19	CDU Night Time Low Noise Operation	Low Noise Operation 0 = Invalid; 1 = Valid	-	09	0~1	0		
		Start Time (Hour)	-	0A	0~23	22		
		End Time (Hour)	-	0B	0~23	06		
20	Alarm Tone	Tone Switching 0 = OFF; 1 = ON	-	11	0~1	1		
21	Second Remote controller and room thermostat	Choice of the initial setting temperature 0 = The fixed temperature by FC9D 1 = The calculated temperature by Auto curve	B5	-	0~1	0		
		Fixed initial temperature setting	9D	-	20~55 °C	40		

		Location & DN Number		Range HWT-60 (HWT-110)	Default HWT-60 (HWT-110)	After Commissioning	Change 1	Change 2
DN Description	Hydro	RC						
22	Operation by external input (option)	Input signal setting when using I/P 7, 8 (CN21) as Emergency shutdown input (DN B6 = 0) 0 = Contacts low > high system stop. System restart with remote controller 1 = Contacts high > low system stop. System restart with remote controller	52	-	0~1	0		
		Input signal setting when using I/P 5, 6 (CN21) 0 = Contacts high > low system stop. Contacts low > high system restart 1 = Contacts low > high system stop. Contacts low > high (second time) system restart	61	-	0~1	0		
		Changing the control of I/P 7, 8 (CN21) Please refer to "Table2" on page 15	B6	-	0~4	0		
23	Hydro Unit type Setting	70: Wall mounted type 71: All in one type	10	-	70 or 71	71		
24	Second Remote controller Target temperature Setting	0 = Water temperature 1 = Room thermo temperature	40	-	0~1	0		
25	Room Temperature Sensor Setting	Temperature shift for heating	-	02	-10~10	-1		
		Temperature shift for cooling	-	03	-10~10	-1		
26	Synchronisation control at low outside temperature	0 = HP + Boiler 1 = Boiler 2 = Backup heater 3 = Boiler (Pump P1:stop)	5B	-	0~3	3		
27	P1 pump speed control (duty of the PWM)	0 = P1 pump fixed speed 1 = P1 pump variable speed	6A6	-	0~1	1		
		0 = 100%, 1 = 90%, 2 = 80% 3 = 70%, 4 = 60%, 5 = 50%	A0	-	100%~50%	0		
28	P2 pump speed control (duty of the PWM)	0 = 100%, 1 = 80% 2 = 70%, 3 = 60%	6A1	-	0~3	0		
29	Restriction of backup heater energization during heating mode	Forcibly heater off at TO ≥ A °C 0 = no restriction, 1 = 20 °C, 2 = 15 °C, ..., 6 = -5 °C	B8	-	0~6	0		
30	Interval operation of the pump 3 min ON/10 min OFF	Intermittent operation at TO ≥ A °C (heating mode) 0 = continuous operation 1 = 20 °C, ..., 6 = -5 °C	BA	-	0~6	0		
		Intermittent operation at TO < B °C (cooling mode) 0 = continuous operation 1 = 35 °C, ..., 3 = 25 °C	BB	-	0~3	0		

	DN Description	Location & DN Number		Range HWT-60 (HWT-110)	Default HWT-60 (HWT-110)	After Commissioning	Change 1	Change 2
		Hydro	RC					
31	Backup heater energization control during defrosting	$\beta$ : 0 = 0K, ..., 4 = 40K Recommendation: $\beta=2$ (20K)	B9	-	0~4	0		
32	Floor drying	Setting Start and End temperature (°C)	-	14	20~55	0		
		Setting Max temperature (°C)	-	15	20~55	0		
		Continuation days for every step up to Max temperature (days)	-	16	1~7	0		
		Temperature difference for every step up to Max temperature (K)	-	17	1~10	0		
		Continuation days for every step down to End temperature (days)	-	18	1~7	0		
		Temperature difference for every step down to End temperature (K)	-	19	1~10	0		
33	Group control	1 = TTW value transmitted from the Master Unit 0 = TTW value of each Hydro Unit	AB	-	0~1	0		
		34	SG Ready	Set point temperature increase during System Forced ON period (K)	AC	-	0~10	0
35	0-10 V interface (option)	Refer to page 18	680	-	0~4	0		
			681	-	0~3	0		
			682	-	0~3	0		
			683	-	0~3	0		
			684	-	0~3	0		
			685	-	40~80	65		
			686	-	20~55 (65)	55		
			687	-	20~55 (65)	55		
			688	-	7~25	20		
			689	-	1~5	5		
			68A	-	1~5	3		
			68B	-	1~5	3		
			68C	-	1~5	1		
36	Hydro Unit Outputs	Refer to page 15	6CA	-	0~9	0		
			6CB	-	0~9	1		
			6CC	-	0~9	2		
			6CD	-	0~9	3		

## ■ Settings by purpose

### Settings when hot water supply function is not used

- When the hot water supply function is not used, set DN "6B8" of Hydro Unit to "1". (Refer to page 20)

### Setting for cooling

- For Hydro Units that do not perform cooling (those for floor heating, etc.), procure a motorized 2-way valve (for cooling) (refer to "Control parts specifications" on page 13 for the details.) locally and attach it to the water pipe that is not used for cooling. Connect the valve cables to terminals CN23 (3) and (4) of the Hydro Unit.

### Settings for hot water supply

- Prepare the optional hot water cylinder.
- Procure a motorized 3-way valve (refer to "Control parts specifications" on page 13 for the details.) locally and perform piping. Connect the valve cables to terminals CN23 (8), (9) and (10) of the Hydro Unit.
- Set DN "6B8" of Hydro Unit to "0". (Refer to page 20)
- Connect the power supply unit for the hot water cylinder heater to terminals TB03 L and N of the Hydro Unit.
- Connect cables between the Hydro Unit and the hot water cylinder as follows: Hydro Unit terminals TB02 (1), (2), and earth — Hot water cylinder (1), (2), and earth  
CN20 (1), (2), and earth — Hot water cylinder A, B, and earth

### Setting for second remote controller

- Prepare the optional second remote controller.
- Connect the cable to terminals TB04 A,B of the Hydro Unit and remote controller.

### Settings for 2-zone temperature control

- Procure a motorized mixing valve (refer to "Control parts specifications" on page 13 for the details.) locally and perform piping. Connect the valve cables to terminals CN22 (7), (8), (9) and (10) of the Hydro Unit.
- Procure a buffer tank locally.
- Procure a water pump locally, and connect its cables to terminals CN23 (1) and (2) of the Hydro Unit. To inhibit interlocking the water pump with the internal pump of the Hydro Unit, set DN "6B5" of Hydro Unit to "0".
- Set DN "6BA" of Hydro Unit to "1". (Refer to page 20) Attach the temperature sensor (TFI) connected to terminals CN20 (3) and (4) of the Hydro Unit near the hot water inlet of the Hydro Unit.
- Fix TFI sensor on the room heating supply pipe by using the connector procured in locally.
- Cover the cables with insulation tube (minimum 1 mm) or conduit so that the user cannot touch them directly.



# 10 Maintenance

Execute periodic maintenance at least once a year.

## Check points

- Check all electrical connections and make adjustments if they are necessary.
- Check the water pipes of the heating systems in particular any evidence of leakage.
- Check the expansion tank inner pressure. If it is insufficient, enclose nitrogen or dry air in the tank.
- Check that the hydraulic pressure is 0.1 MPa (1 bar) or more with a build-in water manometer. If it is insufficient, replenish tap water.
- Clean the strainer.
- Check the pump for an abnormal sound or other abnormalities.
- Operate the domestic hot water safety valve periodically to prevent lime scale blockage and to ensure proper operation of the safety valve.
- In order to prevent corrosion of the enamelled hot water cylinder, a magnesium anode is installed in the tank. The anode has a life expectancy of approximately 2-5 years depending on the water quality. It is recommended to inspect the anode every year. This work has to be performed the a skilled service engineer. Please see the following details.

## Anode

In order to prevent corrosion of the enamelled hot water cylinder, a magnesium anode is installed at the centre top of the tank.

The anode has a life expectancy of approximately 2-5 years depending on the water quality.

It is recommended to inspect the anode every year.

## Checking the anode

1. Disconnect the electrical power supply.
2. Remove the front panel.
3. Remove the centre insulation part at the top of the water cylinder. This allows access to the anode connection.
4. Disconnect the wire connection between the anode and the tank (Refer to "Fig.10-01").
5. Insert a multimeter (range mA) between the anode and the tank. Anode current > 0.3 mA: Anode is active and OK. Anode current < 0.3 mA: Anode should be checked and possibly be replaced.
6. Reconnect the wire connection between the anode and the tank. Reinstall the insulation part and close the front cover. Reconnect the power supply.

▼ Fig.10-01

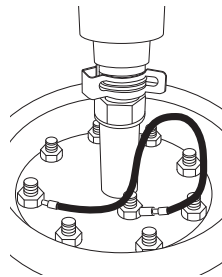

## Replacing the anode

1. Disconnect the electrical power supply.
2. Remove the front panel.
3. Remove the centre insulation part at the top of the water cylinder. This allows access to the centre flange.
4. Close the cold water inlet at the ball valve on the domestic hot safety group.
5. Connect a water hose to the domestic hot water bleed valve next to the safety group. The hose outlet should be at floor level. Lower the hose outlet into a bucket or locate it near a floor drain.
6. Open a hot water tapping point (to avoid vacuum in the water tank).
7. Open the bleed valve and ensure sufficient drainage of water to ensure that the water level in the tank is at least 10 cm below the top of the tank.
8. Remove the hot water outlet flexible pipe from the top of the tank flange by retrieving the connecting clip.
9. Remove the tank flange by means of 8 nuts.
10. Inspect and replace the anode if necessary.
11. Reinstall the flange, and the hot water flexible pipe. Always use a new gasket/spacer ring and new O-rings. Ensure that the connection clip is properly re-installed.
12. Recommission the domestic hot water system as described in the section "Water charging - Domestic water".

## How to drain the water in the tank

Drain using the siphon principle.

### Procedure

1. Connect the drain hose (size: 1/2 inch). Guide the drained side to a drainage ditch (A position lower than the bottom of the AIO unit)
2. Open valve A and close valve B.  
(Refer to "Fig.10-02")
3. Open the domestic hot water outlet side to atmospheric pressure.
4. Apply negative pressure to the drain hose.

Once the water begins to drain, all the water in the tank can be drained by the siphon principle.

▼ Fig.10-02  
Valve description

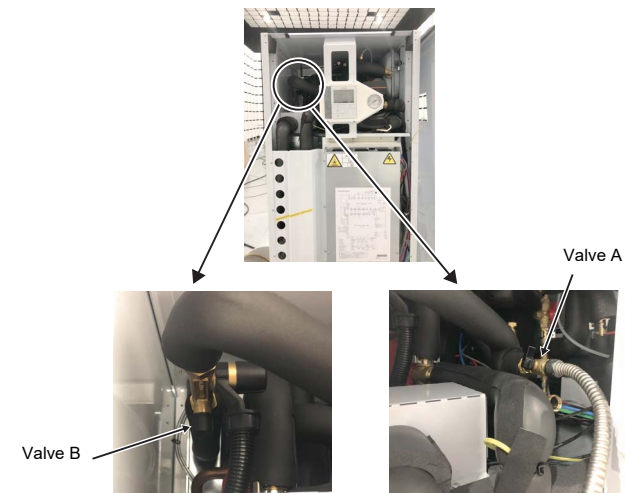

# 11 Troubleshooting

## ■ Fault symptoms

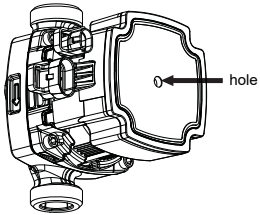
Symptom	Possible cause	Corrective action
Room is not heated or cooled. Water is not hot enough.	Incorrect remote controller setting	Check remote controller operation and temperature setting
	Incorrect function code setting	Check function code setting with the function code table.
	Backup heater disconnected	Check backup heater and bimetal thermostat.
	Insufficient capacity	Check selection of equipment.
	Sensor defect	Check whether temperature sensor is installed at the normal position.
Nothing is displayed on the remote controller.	Power is not supplied.	Check power supply wiring.
	Incorrect setting	Check the setting with the DN codes.
Almost no or little water flow. Error code [A01]	Air bite in the pump	Release air completely according to the procedure.
	Low hydraulic pressure	Set hydraulic pressure considering pipe height, and replenish water until manometer shows a value of set hydraulic pressure or more.
	Strainer is clogged.	Clean the strainer.
	Large resistance on the hydro side	Widen water path to the Hydro Unit or adopt a bypass valve.
	Malfunction of motorized 3-way valve for hot water supply	Check wiring and parts.
Hot water leaks from overpressure preventive valve.	Excessive hydraulic pressure	Set hydraulic pressure considering pipe height, and replenish water until manometer shows a value of set hydraulic pressure or more.
	Insufficient capacity of expansion tank	Check expansion tank capacity compared to total water amount. If it is insufficient, install another expansion tank.
	Expansion tank failure	Check the air pressure.
Pump lock. Error code [A14]	Pump lock due to clogging of dust.	Insert a Phillips screwdriver into the hole and turn to the left or right to unlock.  

## Defect mode detected by the Hydro Unit

Please don't continue backup operation in a state of displaying a check code.

Remove the cause of the anomaly immediately.

○ ....Possible  
× .....Not possible

Check code	Diagnostic functional operation			Determination and action
	Operational cause	Backup operation	Automatic reset	
A01	<b>Pump or flowing quantity error</b> Detected by flow rate abnormality	×	×	1. Almost no or little water flow. • Not enough vent air • Dirt clogging in the water piping system. • The water piping is too long. • Installation of buffer tank and secondary pump
A02	<b>Temperature increase error</b> (heating) (TWI, TWO, THO)	×	○	1. Check the water inlet, water outlet and heater outlet (TWI, TWO, THO) sensors. 2. Defect of the backup heater (defect automatic reset thermostat).
A03	<b>Temperature increase error</b> (hot water supply) (TTW)	Heating ○ Hot water ×	○	1. Check the hot water cylinder sensor (TTW). 2. Check the hot water cylinder thermal cut-out.
A04	<b>Antifreeze operation</b>	○	×	1. Almost no or little water flow. • Dirt clogging in the water piping system. • The water piping is too long or too short. 2. Check the heater power circuit. • Power supply voltage, breaker, power supply connection 3. Set the presence of the backup heater. 4. Check the water inlet, water outlet and heat exchange (TWI, TWO, TC) sensors and flow sensor.
A05	<b>Piping antifreeze operation</b>	○	○	1. Check the heater power circuit. • Power supply voltage, breaker, power supply connection 2. Check the water inlet, water outlet and heater outlet sensors (TWI, TWO, THO). 3. Disconnection of the backup heater.
A08	<b>Low pressure sensor operation error</b>	○	×	1. Almost no or little water flow. 2. Defect of the flow sensor. 3. On-load cooling or prolonged defrosting (a lot of frost formation) under the above conditions. 4. Defect in the low pressure sensor. 5. Check the refrigeration cycle (gas leak).
A09	<b>Overheat protection operation</b> (Thermostat of the backup heater)	×	×	1. No water (heating without water) or no water flow. 2. Defect of the flow sensor. 3. Defect of the backup heater (poor automatic reset thermostat).
A10	<b>Antifreeze operation 2</b>	Heating ×	×	1. Almost no or little water flow. 2. Check the water inlet, water outlet and heat exchange (TWO, TC) sensors.
A11	<b>Operation of the release protection</b>	Heating ×	×	1. Almost no water flow. 2. Defect of the flow sensor. 3. Check the water outlet temperature sensor (TWO).

O ....Possible  
x.....Not possible

Check code	Diagnostic functional operation			Determination and action
	Operational cause	Backup operation	Automatic reset	
A12	<b>Heating, hot water heater error</b>	O	O	1. Activated by a large load of heating or hot water supply. 2. Check the heater power circuit (backup or hot water cylinder heater). • Power supply voltage, breaker, power supply connection
A13	<b>Pump error</b>	x	x	1. Pump has stopped by a certain cause. • Low supply voltage. • High humidity around the electric box of the pump. • Dew condensation to the electric board of the pump. • Once turn off the power supply to the system and turn on again and operate the system.
A14	<b>Pump error</b>	x	x	• Low supply voltage. • Pump lock due to clogging of dust.
A15	<b>Pump error (for zone2)</b>	O	x	• Low supply voltage. • Pump lock due to clogging of dust.
E03	<b>Regular communication error between Hydro Unit and remote controller</b>	x	O	1. Check remote controller connection. 2. Defect in the remote controller.
E04	<b>Regular communication error between Hydro Unit and Outdoor Unit</b>	O	O	1. Check the serial circuit. • Miswiring of the crossover between the Hydro Unit and the Outdoor Unit
E08	<b>Duplicate address of Hydro Unit, or Duplicate master Hydro Unit during Group control</b>	x	O	1. Check Hydro Unit addresses. (DN 14)
E14	<b>Regular communication error between Hydro Unit and 0-10V-IF</b>	x	O	1. Check the 0-10V-IF connection. 2. Defect in the 0-10V-IF.
E18	<b>Regular communication error between master Hydro Unit and slave Hydro Unit during Group control</b>	x	O	1. Check the Hydro Unit connection. • Miswiring of the master and slave Hydro Unit.
F03	<b>TC sensor error</b>	O	O	1. Check the resistance value and connection of the heat exchange temperature sensor (TC).
F10	<b>TWI sensor error</b>	O	O	1. Check the resistance value and connection of the water inlet temperature sensor (TWI).
F11	<b>TWO sensor error</b>	x	O	1. Check the resistance value and connection of the water outlet temperature sensor (TWO).
F14	<b>TTW sensor error</b>	Heating O Hot water x	O	1. Check the resistance value and connection of the hot water cylinder sensor (TTW).
F17	<b>TFI sensor error</b>	Heating x Hot water O	O	1. Check the resistance value and connection of the floor-inlet temperature sensor (TFI).
F18	<b>THO sensor error</b>	x	O	1. Check the resistance value and connection of the heater outlet temperature sensor (THO).
F19	<b>Detection of THO disconnection error</b>	x	x	1. Check for any disconnection of the heater outlet temperature sensor (THO).

O ....Possible  
x.....Not possible

Check code	Diagnostic functional operation			Determination and action
	Operational cause	Backup operation	Automatic reset	
F20	<b>TFI sensor error</b>	Heating x Hot water O	x	1. Check the connection of the floor-inlet temperature sensor (TFI).
F23	<b>Low pressure sensor error</b>	O	O	1. Check the connection (body or connection wiring) of the low pressure sensor. 2. Check the resistance value of the low pressure sensor.
F29	<b>EEROM error</b>	x	x	1. Replace the P.C. board. (Hydro Unit)
F30	<b>Extended IC error</b>	x	x	1. Replace the P.C. board. (Hydro Unit)
F32	<b>Flow sensor error</b>	x	O	1. Check the connection of flow sensor. 2. Check the water flow from the external pump. 3. Check the flow rate detected by flow sensor and actual flow.
F33	<b>Flowing quantity error</b> 1)Detected by TC sensor TC ≥ 68 °C is detected in the heating or hot water supply heat pump operation(except for defrosting). 2)Detected by flowing quantity When the stopped built-in circulation pump starts its operation, the flow sensor status is detecting "water flow".	x	x	No or little water flow Defect of the flow sensor  Defect of the flow sensor
L02	<b>Combination error</b> Model name of the Outdoor Unit is different.	x	x	1. Check the model name of the Outdoor Unit.
L03	<b>Duplicate main Hydro unit during Group control</b> There are more than one header units in group.	x	x	1. Check Hydro Unit addresses. (DN 14) 2. Check for any change made to remote control connection (group/individual) since Hydro address setting.
L07	<b>Group line in individual Hydro Unit</b> There is at least one standalone Hydro Unit to which group control cable is connected.	x	x	1. Check Hydro Unit addresses. (DN 14)
L08	<b>Hydro Unit group / Address unset</b> Address setting has not been performed for indoor units.	x	x	1. Check Hydro Unit addresses. Note: This code is displayed when power is turned on for the first time after installation.
L09	<b>Hydro Unit capacity unset</b>	x	x	1. Set Hydro Unit capacity. (DN 11)
L16	<b>Setting error</b> When ZONE1 has not been set, while ZONE2 has been set.	x	x	1. Check the DN_6B9, 6BA.
L22	<b>0-10V Setting error</b> DN680 settings in group control are not the same for all units.	x	x	1. Check the 0-10V setting for all units. (DN680)
P31	<b>Slave Hydro Unit error which occurs when error occurs in master Hydro Unit</b>	x	O	1. Check the remote controller connection. 2. Defect in the remote controller. 3. Check Hydro Unit addresses.

## Defect mode detected by the Outdoor Unit

Check code	Diagnostic functional operation			Determination and action
	Operational cause	Backup operation	Automatic reset	
F04	<b>TD sensor error</b>	O	x	1. Check the resistance value and connection of the discharge sensor (TD).
F06	<b>TE sensor error</b>	O	x	1. Check the resistance value and connection of the heat exchange temperature sensor (TE).
F07	<b>TL sensor error</b>	O	x	1. Check the resistance value and connection of the heat exchange temperature sensor (TL).
F08	<b>TO sensor error</b>	O	x	1. Check the resistance value and connection of the outdoor temperature sensor (TO).
F12	<b>TS sensor error</b>	O	x	1. Check the resistance value and connection of the suction temperature sensor (TS).
F13	<b>TH sensor error</b>	O	x	1. Check the resistance value and connection of the heat-sink temperature sensor (TH).
F15	<b>TE, TS sensors error</b>	O	x	1. Check for any wrong installation of the heat exchange temperature sensor (TE) and the suction temperature sensor (TS).
F24	<b>PD sensor error</b>	O	x	1. Check the value of PD sensor by the remote controller and connection of the PD sensor.
F31	<b>EEPROM error</b>	O	x	1. Replace the outdoor control board.
H01	<b>Compressor breakdown</b>	O	x	1. Check the power supply voltage. 2. Over-loaded condition of the refrigeration cycle. 3. Check that the service valve is fully open.
H02	<b>Compressor lock</b>	O	x	1. Defect of compressor (lock) – Replace the compressor. 2. Defect of compressor wiring (open phase).
H03	<b>Defect in the current detection circuit</b>	O	x	1. Replace the outdoor inverter control board.
H04	<b>Operation of case thermostat</b>	O	x	1. Check the refrigeration cycle (gas leak). 2. Check the case thermostat and connector. 3. Check that the service valve is fully open. 4. Defect of the pulse motor valve. 5. Check for kinked piping.
L10	<b>Unset service PC board jumper</b> Jumpers have not been cut.	O	x	1. Cut outdoor PC board jumper wire (for service).
L15	<b>Combination error</b> Model name of the Hydro Unit is different.	x	x	1. Check the model name of the Hydro Unit.
L29	<b>The communication between the outdoor PC board MUCs error</b>	O	x	1. Replace the outdoor control board.
P03	<b>The outlet temperature error</b>	O	x	1. Check the refrigeration cycle (gas leak). 2. Defect of the pulse motor valve. 3. Check the resistance value of the discharge temperature sensor (TD).
P04	<b>The high pressure switch error</b>	O	x	1. Almost no or little water flow. 2. Defect of the flow sensor. 3. On-load operation under the above conditions. 4. Defect in the high pressure switch. 5. Failure of a refrigerant valve to open.
P05	<b>The power supply voltage error</b>	O	x	1. Check the power supply voltage.

Check code	Diagnostic functional operation			Determination and action
	Operational cause	Backup operation	Automatic reset	
P07	<b>Overheating of heat-sink error</b>	O	x	1. Check the thread fastening and heat-sink grease between the outdoor control board and the heat-sink. 2. Check the heat-sink fan duct. 3. Check the resistance value of the heat-sink temperature sensor (TH).
P15	<b>Detection of gas leak</b>	O	x	1. Check the refrigeration cycle (gas leak). 2. Check that the service valve is fully open. 3. Defect of the pulse motor valve. 4. Check for kinked piping. 5. Check the resistance value of the discharge temperature sensor (TD), the suction temperature sensor (TS). 6. Check the value of PD sensor by the remote controller.
P19	<b>The 4-way valve inversion error</b>	O	x	1. Check the operation of the 4-way valve unit or the coil characteristics. 2. Defect of the pulse motor valve. 3. Check the resistance value of the heat exchange temperature sensor (TE) and the suction temperature sensor (TS).
P20	<b>High pressure protection operation</b>	O	x	1. Check that the service valve is fully open. 2. Defect of the pulse motor valve. 3. Check the outdoor fan system (including clogging). 4. Over-filling of refrigerant. 5. Check the value of PD sensor by the remote controller. 6. The water piping is too short. Install a buffer tank or set the setting temperature lower.
P22	<b>Outdoor fan system error</b>	O	x	1. Check the lock status of the motor fan. 2. Check the connection of the fan motor cable connector. 3. Check the power supply voltage.
P26	<b>Short circuit of the compressor driver element error</b>	O	x	1. Abnormality occurs when operating with the compressor wiring disconnected ... Check the control board. 2. No abnormality occurs when operating with the compressor wiring disconnected ... Compressor rare short.
P29	<b>Compressor rotor position error</b>	O	x	1. Even if the connection lead wire of the compressor is disconnected, it stops due to an abnormality in the position detection ... Replace the inverter control board. 2. Check the wire wound resistor of the compressor. Short circuit ... Replace the compressor.

## Defect mode detected by the remote controller

Check code	Diagnostic functional operation			Determination and action
	Operational cause	Status of air-conditioning	Condition	
Not displaying at all (cannot operate by the remote controller)	<b>No communication between Hydro Unit and remote controller</b>	Stop	–	Defect in the remote controller power supply 1. Check the remote controller wiring. 2. Check the remote controller. 3. Check the Hydro Unit power supply wiring. 4. Check the water heat exchange control board.
E01	<b>No communication between Hydro Unit and remote controller</b>	Stop (Automatic reset)	Displayed when the abnormality is detected.	Defect in the reception of the remote controller 1. Check the remote controller crossover. 2. Check the remote controller. 3. Check the hydro power supply wiring. 4. Check the water heat exchanger board.
E02	<b>Defect in the signal transmission to the Hydro Unit.</b> (Detected on the remote controller side)	Stop (Automatic reset)	Displayed when the abnormality is detected.	Defect in the transmission of the remote controller 1. Check the transmitter circuit inside the remote controller. ... Replace the remote controller.
E09	<b>Several remote controller base units</b> (Detected on the remote controller side)	Stop (The handset continues)	Displayed when the abnormality is detected.	1.2 Check several base units with the remote controller ... The base unit is only one, and others are handsets.

# 12 Technical parameters

## Technical parameters for heat pump combination heater

Climate condition : average climate

Models	Outdoor Unit		HWT-401HW-E	HWT-601HW-E		
	Hydro Unit		HWT-601F21SM3W-E HWT-601F21ST6W-E			
Air-to-Water Heat Pump			yes	yes		
Water-to-water heat pump			no	no		
Brine-to-water heat pump			no	no		
Low-temperature heat pump			no	no		
Equipped with a supplementary heater			no	no		
Heat pump combination heater			yes	yes		
Parameters for Low-temperature application/ Medium-temperature application			Medium	Medium		
Item	Symbol		Unit		Value	
	Rated heat output (*)		P <sub>rated</sub>	kW	5	6
Item	Seasonal space heating energy efficiency		η <sub>s</sub>	%	135	132
	Declared capacity for heating for part load at indoor temperature 20 °C and outdoor temperature T <sub>j</sub>	T <sub>j</sub> = - 7 °C	P <sub>dh</sub>	kW	4.0	5.0
		T <sub>j</sub> = + 2 °C	P <sub>dh</sub>	kW	2.5	3.4
		T <sub>j</sub> = + 7 °C	P <sub>dh</sub>	kW	1.6	2.0
		T <sub>j</sub> = + 12 °C	P <sub>dh</sub>	kW	1.5	1.5
		T <sub>j</sub> = bivalent temperature	P <sub>dh</sub>	kW	4.0	5.0
		T <sub>j</sub> = operation limit temperature	P <sub>dh</sub>	kW	3.5	4.5
		T <sub>j</sub> = - 15 °C (if TOL < - 20 °C)	P <sub>dh</sub>	kW	-	-
	Bivalent temperature	T <sub>biv</sub>	°C	-7	-7	
	Cycling interval capacity for heating	P <sub>cyh</sub>	kW	-	-	
	Degradation co-efficient (**)	C <sub>dh</sub>	-	0.8	0.8	
	Declared coefficient of performance or primary energy ratio for part load at indoor temperature 20 °C and outdoor temperature T <sub>j</sub>	T <sub>j</sub> = - 7 °C	COP <sub>d</sub>	-	2.18	2.10
		T <sub>j</sub> = + 2 °C	COP <sub>d</sub>	-	3.48	3.22
		T <sub>j</sub> = + 7 °C	COP <sub>d</sub>	-	4.28	4.58
		T <sub>j</sub> = + 12 °C	COP <sub>d</sub>	-	6.35	6.35
T <sub>j</sub> = bivalent temperature		COP <sub>d</sub>	-	2.18	2.10	
T <sub>j</sub> = operation limit temperature	COP <sub>d</sub>	-	1.83	1.81		
T <sub>j</sub> = - 15 °C (if TOL < - 20 °C)	COP <sub>d</sub>	-	-	-		
Operation limit temperature	TOL	°C	-10	-10		
Cycling interval efficiency	P <sub>cyh</sub>	-	-	-		
Heating water operating limit temperature	WTOL	°C	55	55		
Power consumption in modes other than active mode	Off mode	P <sub>OFF</sub>	kW	0.008	0.008	
	Thermostat-off mode	P <sub>TO</sub>	kW	0.040	0.040	
	Standby mode	P <sub>SB</sub>	kW	0.008	0.008	
	Crankcase heater mode	P <sub>CK</sub>	kW	0.008	0.008	
Supplementary heater	Rated heat output (*)	P <sub>sup</sub>	kW	5	6	
	Type of energy input			220-240V ~, 50Hz	220-240V ~, 50Hz	
Other items	Capacity control			variable	variable	
	Sound power level, indoors/outdoors	L <sub>WA</sub>	dB	42/65	42/65	
	Rated air flow rate, outdoors	-	m <sup>3</sup> /h	2015	2015	
For heat pump combination heater	Declared load profile	-	-	L	L	
	Daily electricity consumption	Q <sub>elec</sub>	kWh	3.627	3.627	
	Water heating energy efficiency	η <sub>wh</sub>	%	136	136	
Contact details	Toshiba Carrier Air-conditioning Europe Sp. z o.o. ul. Gdańska 131, 62-200 Gniezno, Poland					

(\*) For heat pump space heaters and heat pump combination heaters, the rated heat output Prated is equal to the design load for heating Pdesignh, and the rated heat output of a supplementary heater Psup is equal to the supplementary capacity for heating sup(T<sub>j</sub>).

(\*\*) If Cdh is not determined by measurement then the default degradation coefficient is Cdh = 0.9.

## Technical parameters for heat pump combination heater

Climate condition : average climate

Models	Outdoor Unit		HWT-801H (R)W-E	HWT-1101H (R)W-E		
	Hydro Unit		HWT-1101F21SM3W-E, HWT-1101F21MM3W-E HWT-1101F21ST6W-E, HWT-1101F21MT6W-E HWT-1101F21ST9W-E, HWT-1101F21MT9W-E			
Air-to-Water Heat Pump			yes	yes		
Water-to-water heat pump			no	no		
Brine-to-water heat pump			no	no		
Low-temperature heat pump			no	no		
Equipped with a supplementary heater			no	no		
Heat pump combination heater			yes	yes		
Parameters for Low-temperature application/ Medium-temperature application			Medium	Medium		
Item	Symbol		Unit		Value	
	Rated heat output (*)		P <sub>rated</sub>	kW	8	8
Item	Seasonal space heating energy efficiency		η <sub>s</sub>	%	142	142
	Declared capacity for heating for part load at indoor temperature 20 °C and outdoor temperature T <sub>j</sub>	T <sub>j</sub> = - 7 °C	P <sub>dh</sub>	kW	7.3	7.3
		T <sub>j</sub> = + 2 °C	P <sub>dh</sub>	kW	4.6	4.5
		T <sub>j</sub> = + 7 °C	P <sub>dh</sub>	kW	3.0	3.0
		T <sub>j</sub> = + 12 °C	P <sub>dh</sub>	kW	2.3	2.3
		T <sub>j</sub> = bivalent temperature	P <sub>dh</sub>	kW	7.3	7.3
		T <sub>j</sub> = operation limit temperature	P <sub>dh</sub>	kW	6.7	6.7
		T <sub>j</sub> = - 15 °C (if TOL < - 20 °C)	P <sub>dh</sub>	kW	-	-
	Bivalent temperature	T <sub>biv</sub>	°C	-7	-7	
	Cycling interval capacity for heating	P <sub>cyh</sub>	kW	-	-	
	Degradation co-efficient (**)	C <sub>dh</sub>	-	0.9	0.9	
	Declared coefficient of performance or primary energy ratio for part load at indoor temperature 20 °C and outdoor temperature T <sub>j</sub>	T <sub>j</sub> = - 7 °C	COP <sub>d</sub>	-	2.12	2.12
		T <sub>j</sub> = + 2 °C	COP <sub>d</sub>	-	3.60	3.58
		T <sub>j</sub> = + 7 °C	COP <sub>d</sub>	-	4.75	4.75
		T <sub>j</sub> = + 12 °C	COP <sub>d</sub>	-	7.00	7.00
T <sub>j</sub> = bivalent temperature		COP <sub>d</sub>	-	2.12	2.12	
T <sub>j</sub> = operation limit temperature	COP <sub>d</sub>	-	1.90	1.89		
T <sub>j</sub> = - 15 °C (if TOL < - 20 °C)	COP <sub>d</sub>	-	-	-		
Operation limit temperature	TOL	°C	-10	-10		
Cycling interval efficiency	P <sub>cyh</sub>	-	-	-		
Heating water operating limit temperature	WTOL	°C	65	65		
Power consumption in modes other than active mode	Off mode	P <sub>OFF</sub>	kW	0.007	0.007	
	Thermostat-off mode	P <sub>TO</sub>	kW	0.049	0.049	
	Standby mode	P <sub>SB</sub>	kW	0.007	0.007	
	Crankcase heater mode	P <sub>CK</sub>	kW	0.000	0.000	
Supplementary heater	Rated heat output (*)	P <sub>sup</sub>	kW	8	8	
	Type of energy input			220-240V ~, 50Hz	220-240V ~, 50Hz	
Other items	Capacity control			variable	variable	
	Sound power level, indoors/outdoors	L <sub>WA</sub>	dB	42 (F21S), 44 (F21M) / 65	42 (F21S), 44 (F21M) / 65	
	Rated air flow rate, outdoors	-	m <sup>3</sup> /h	3142	3506	
For heat pump combination heater	Declared load profile	-	-	XL	XL	
	Daily electricity consumption	Q <sub>elec</sub>	kWh	6.110	6.110	
	Water heating energy efficiency	η <sub>wh</sub>	%	130	130	
Contact details	Toshiba Carrier Air-conditioning Europe Sp. z o.o. ul. Gdańska 131, 62-200 Gniezno, Poland					

(\*) For heat pump space heaters and heat pump combination heaters, the rated heat output Prated is equal to the design load for heating Pdesignh, and the rated heat output of a supplementary heater Psup is equal to the supplementary capacity for heating sup(T<sub>j</sub>).

(\*\*) If Cdh is not determined by measurement then the default degradation coefficient is Cdh = 0.9.

# **Toshiba Carrier Air-Conditioning Europe Sp.z o.o.**

ul. Gdańska 131, 62-200 Gniezno, Poland

**0714305099-1**